

EGB2420-E40 INA

Plain bushes

TYPE: Plain bearings, Bushings, thrust washers and strips, Bushings, Without flange, Maintenance-free, with steel backing (INA)

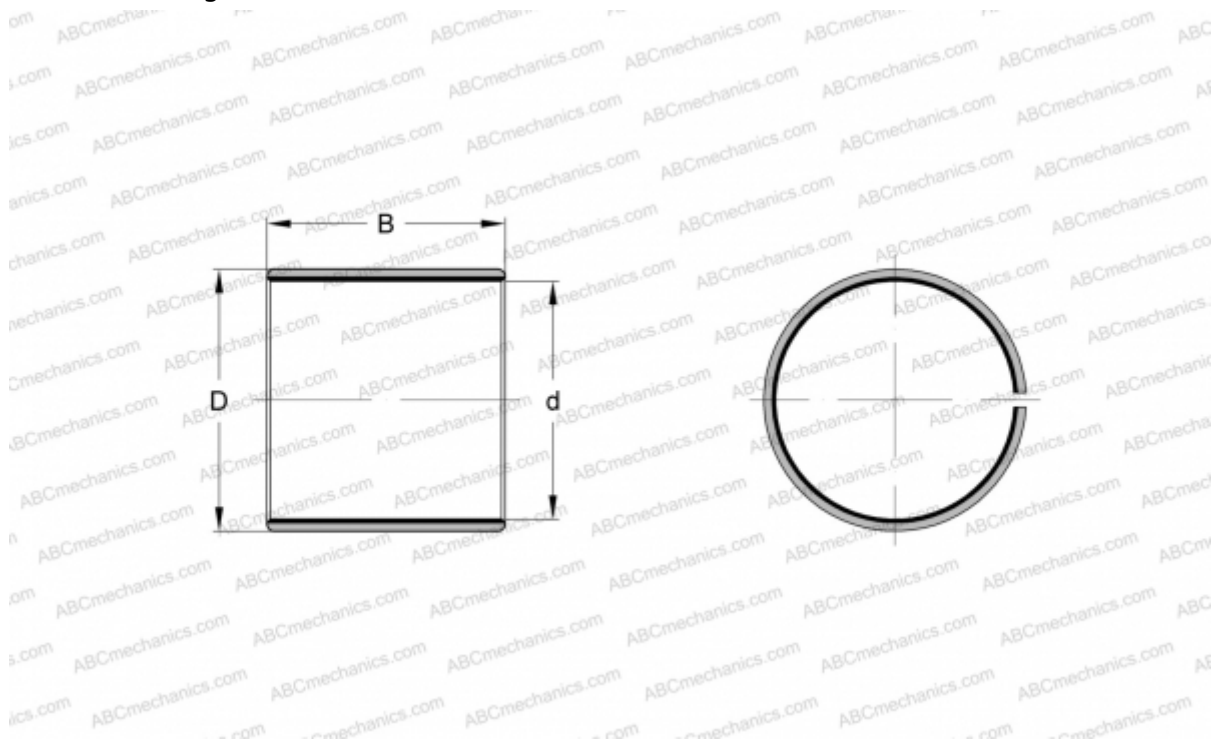

Technical specification

DIMENSIONS, MM

d	24,000
D	27,000
B	20,000

WEIGHT, KG 0,018

MANUFACTURER [INA](#)

REPLACES

PAP2420-P14