

EGB3015-E40 INA

Plain bushes

TYPE: Plain bearings, Bushings, thrust washers and strips, Bushings, Without flange, Maintenance-free, with steel backing (INA)

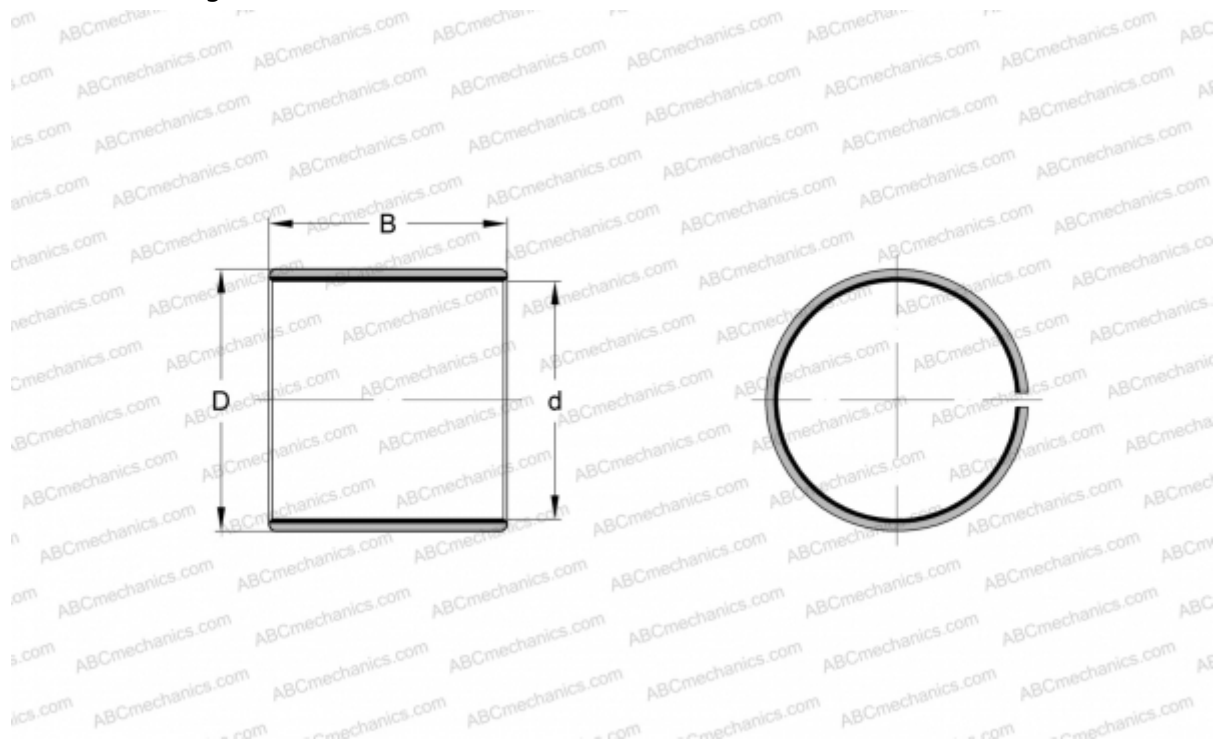

Technical specification

DIMENSIONS, MM

d	30,000
D	34,000
B	15,000

WEIGHT, KG 0,022

MANUFACTURER [INA](#)

REPLACES

PAP3015-P14