

EGB4020-E40 INA

Plain bushes

TYPE: Plain bearings, Bushings, thrust washers and strips, Bushings, Without flange, Maintenance-free, with steel backing (INA)

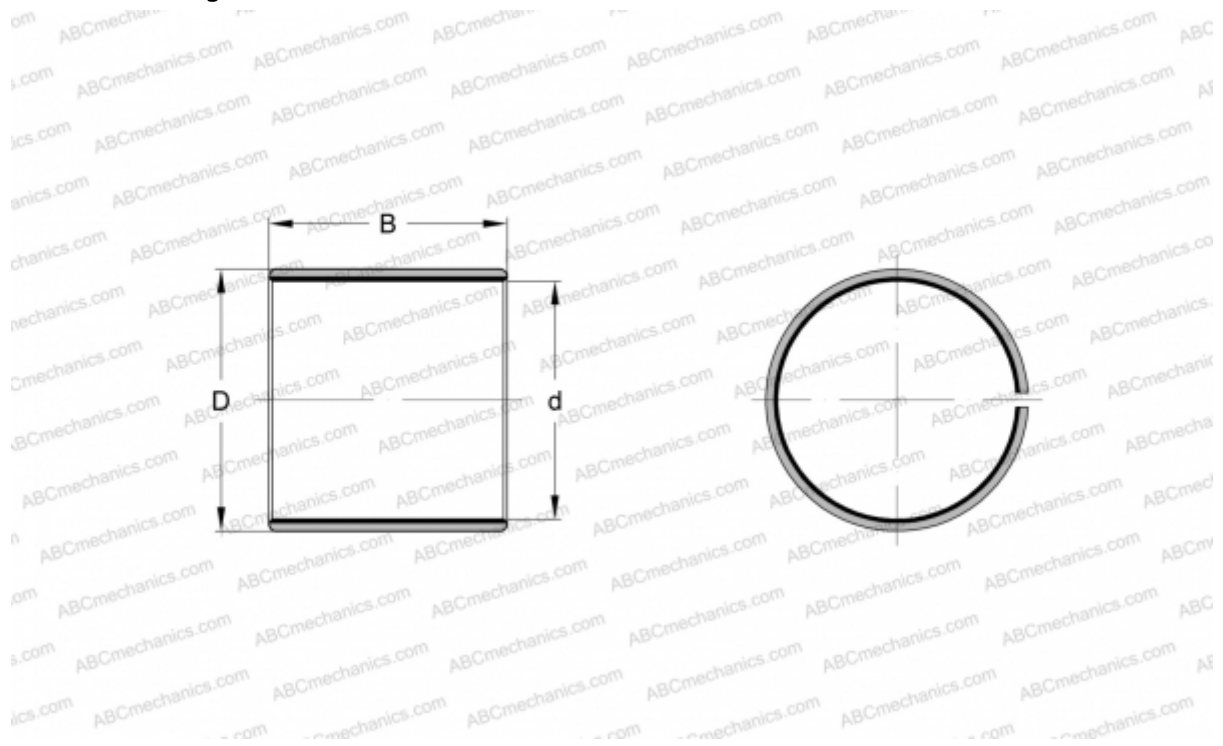

Technical specification

DIMENSIONS, MM

d	40,000
D	44,000
B	20,000

WEIGHT, KG 0,039

MANUFACTURER [INA](#)

REPLACES

PAP4020-P14