

EGB4530-E40 INA

Plain bushes

TYPE: Plain bearings, Bushings, thrust washers and strips, Bushings, Without flange, Maintenance-free, with steel backing (INA)

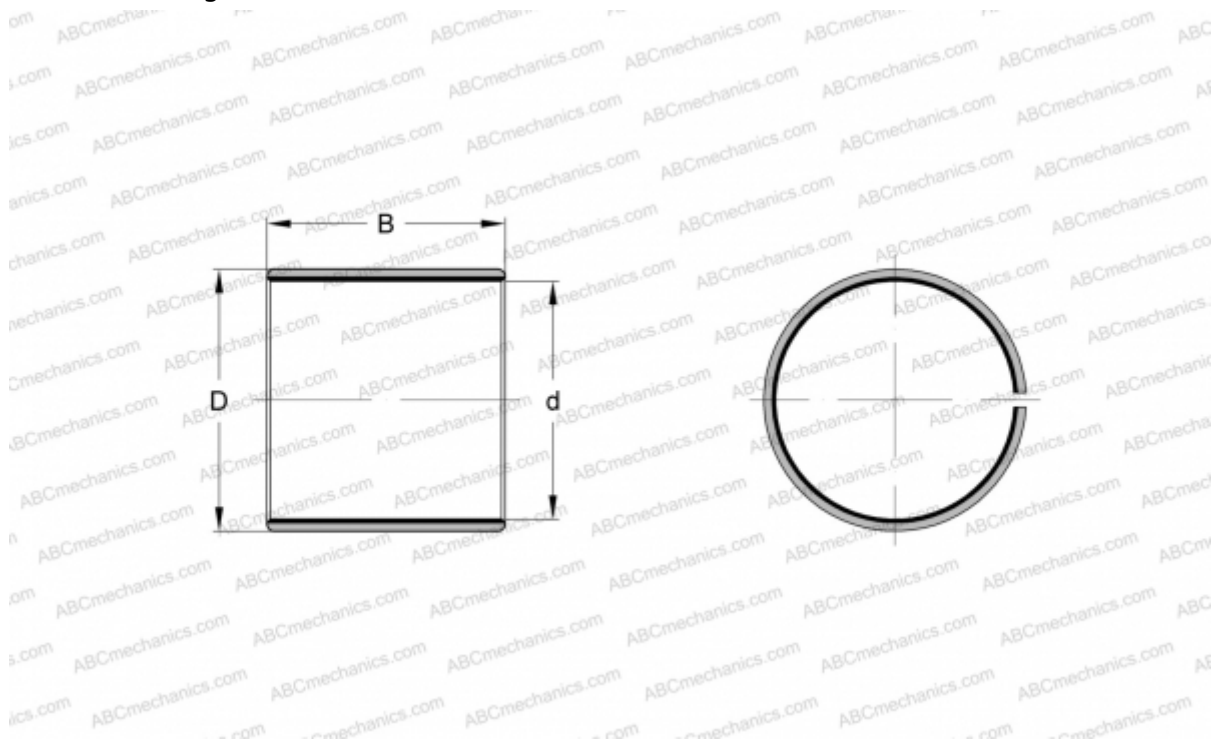

Technical specification

DIMENSIONS, MM

d	45,000
D	50,000
B	30,000

WEIGHT, KG 0,083

MANUFACTURER [INA](#)

REPLACES

PAP4530-P14