

EGB5560-E40 INA

Plain bushes

TYPE: Plain bearings, Bushings, thrust washers and strips, Bushings, Without flange, Maintenance-free, with steel backing (INA)

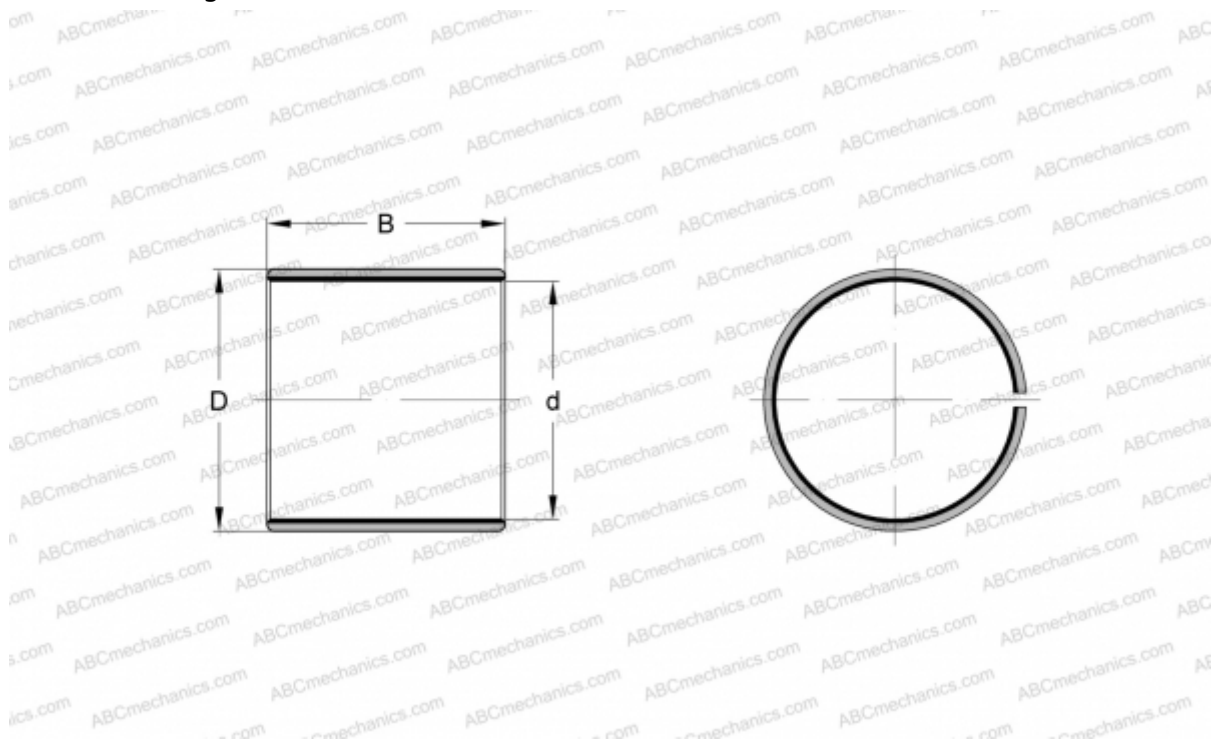

Technical specification

DIMENSIONS, MM

d	55,000
D	60,000
B	60,000

WEIGHT, KG 0,203

MANUFACTURER [INA](#)

REPLACES

PAP5560-P14