

EGB6530-E40 INA

Plain bushes

TYPE: Plain bearings, Bushings, thrust washers and strips, Bushings, Without flange, Maintenance-free, with steel backing (INA)

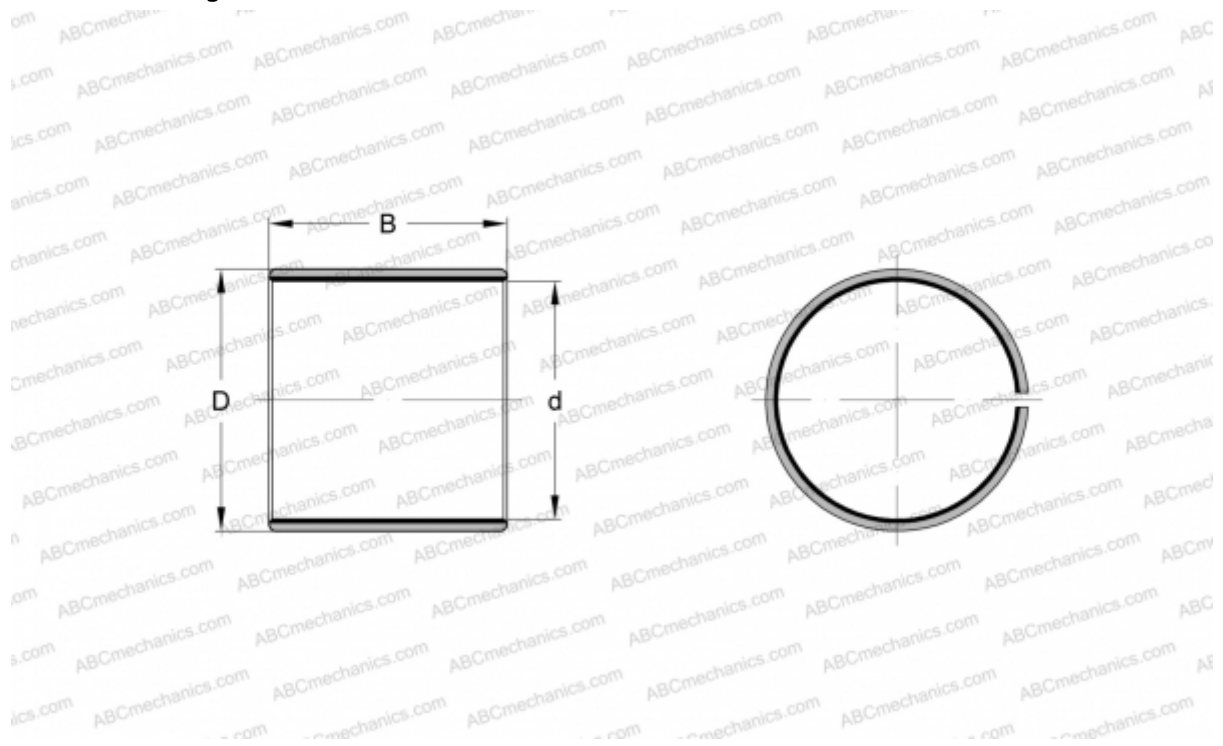

Technical specification

DIMENSIONS, MM

d	65,000
D	70,000
B	30,000

WEIGHT, KG 0,119

MANUFACTURER [INA](#)

REPLACES

PAP6530-P14