

EGB7050-E40 INA

Plain bushes

TYPE: Plain bearings, Bushings, thrust washers and strips, Bushings, Without flange, Maintenance-free, with steel backing (INA)

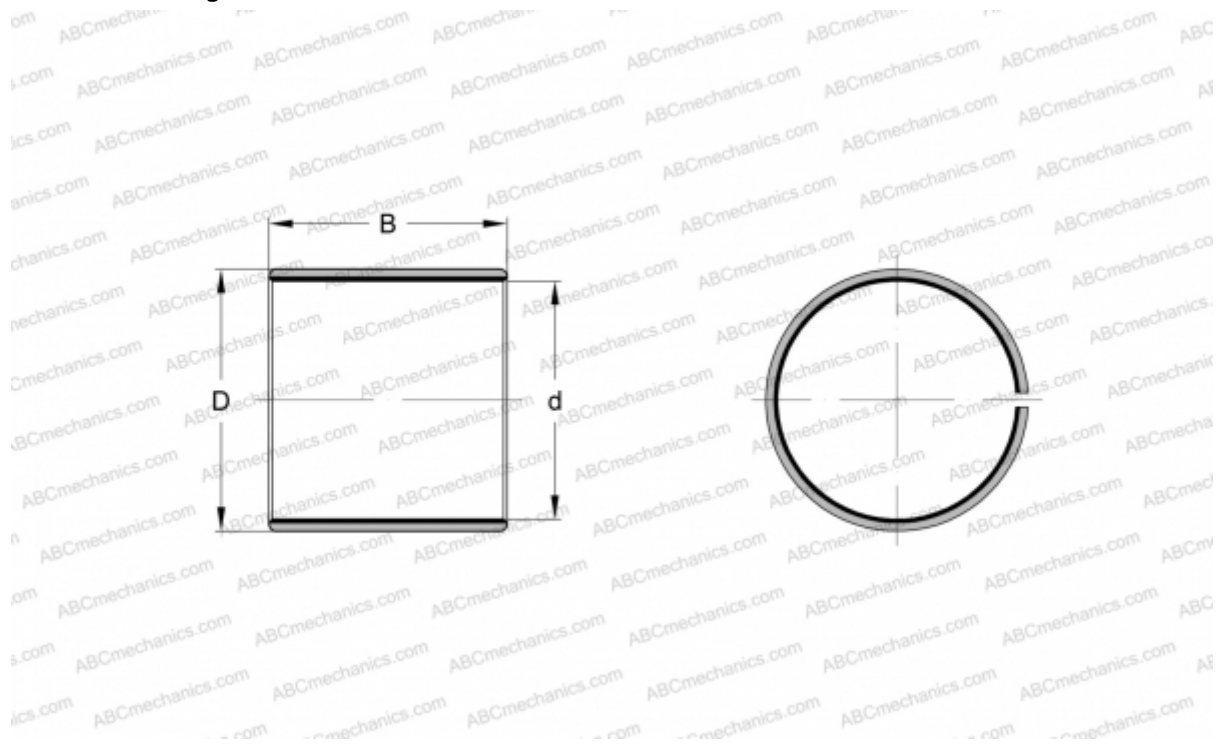

Technical specification

DIMENSIONS, MM

d	70,000
D	75,000
B	50,000

WEIGHT, KG 0,214

MANUFACTURER [INA](#)

REPLACES

PAP7050-P14