

EGB9560-E40 INA

Plain bushes

TYPE: Plain bearings, Bushings, thrust washers and strips, Bushings, Without flange, Maintenance-free, with steel backing (INA)

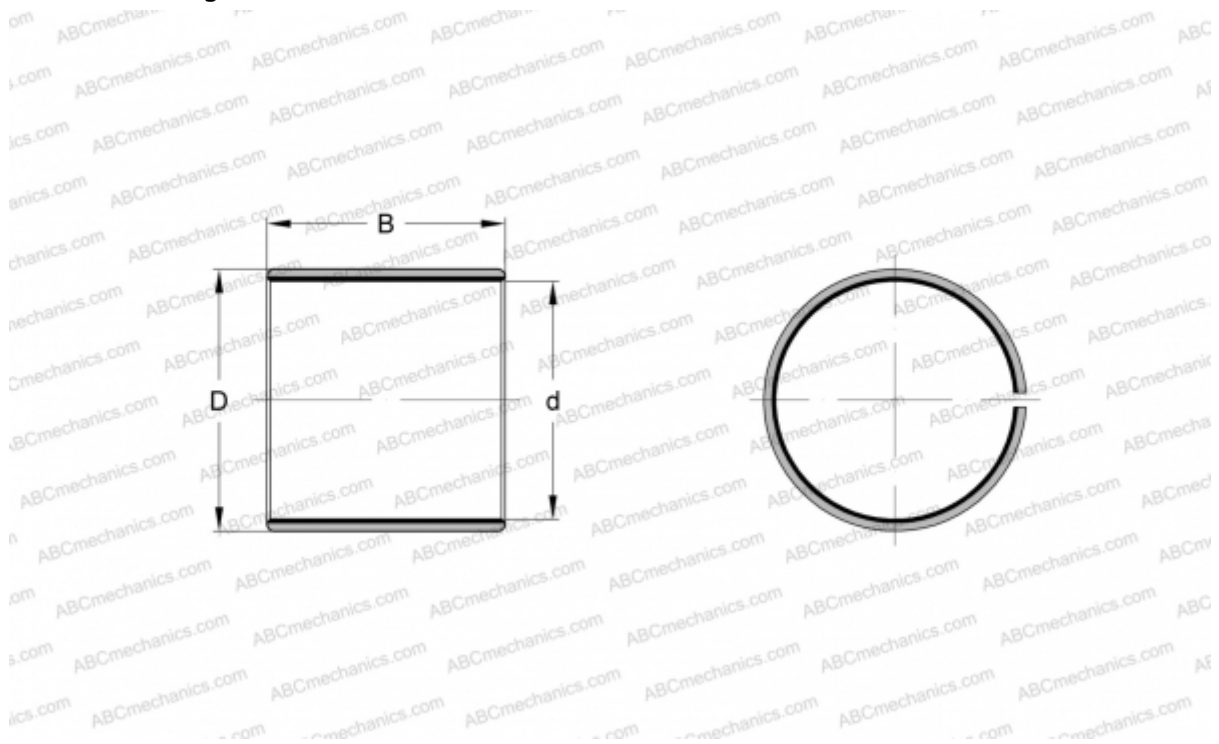

Technical specification

DIMENSIONS, MM

d	95,000
D	100,000
B	60,000

WEIGHT, KG 0,345

MANUFACTURER [INA](#)

REPLACES

PAP9560-P14