

## EGBZ0303-E40 INA

Plain bushes

TYPE: Plain bearings, Bushings, thrust washers and strips, Bushings, Without flange, Maintenance-free, with steel backing, inch size (INA)

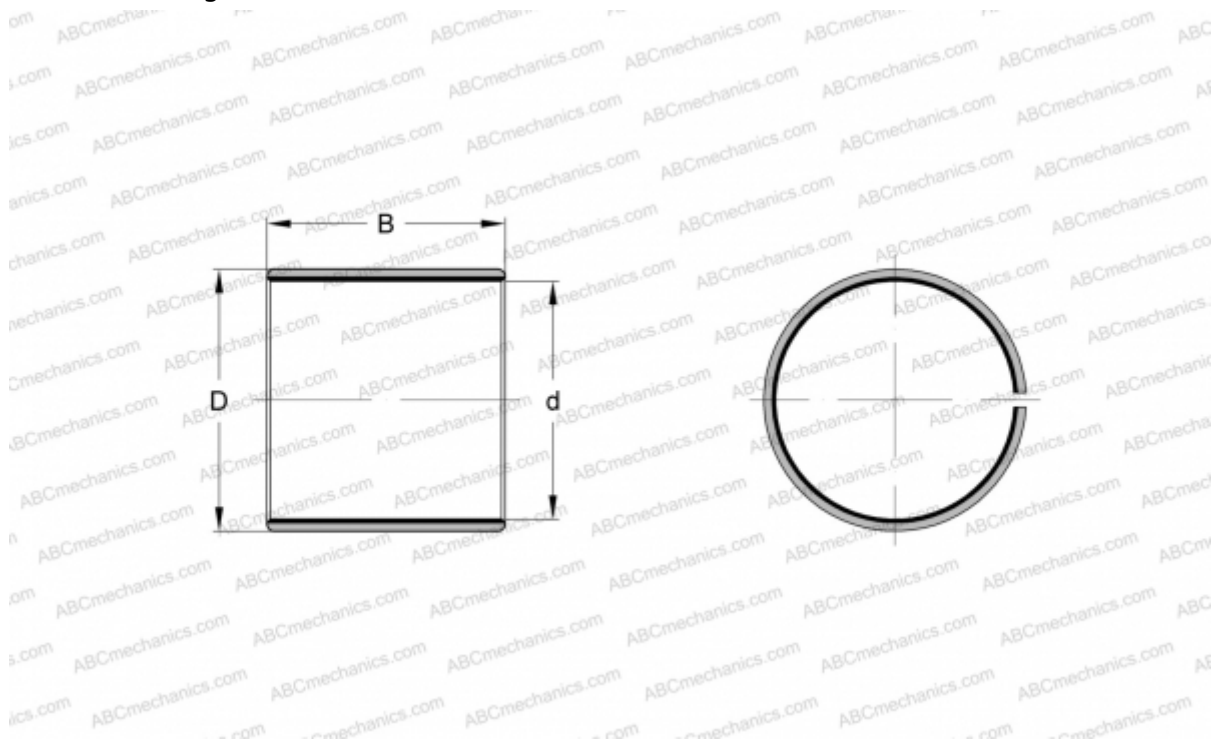

### Technical specification

#### DIMENSIONS, MM

d	4,763
D	6,350
B	4,760

**WEIGHT, KG** 0,001

**MANUFACTURER** [INA](#)

#### REPLACES

PAPZ0303-P14