

EGBZ0610-E40 INA

Plain bushes

TYPE: Plain bearings, Bushings, thrust washers and strips, Bushings, Without flange, Maintenance-free, with steel backing, inch size (INA)

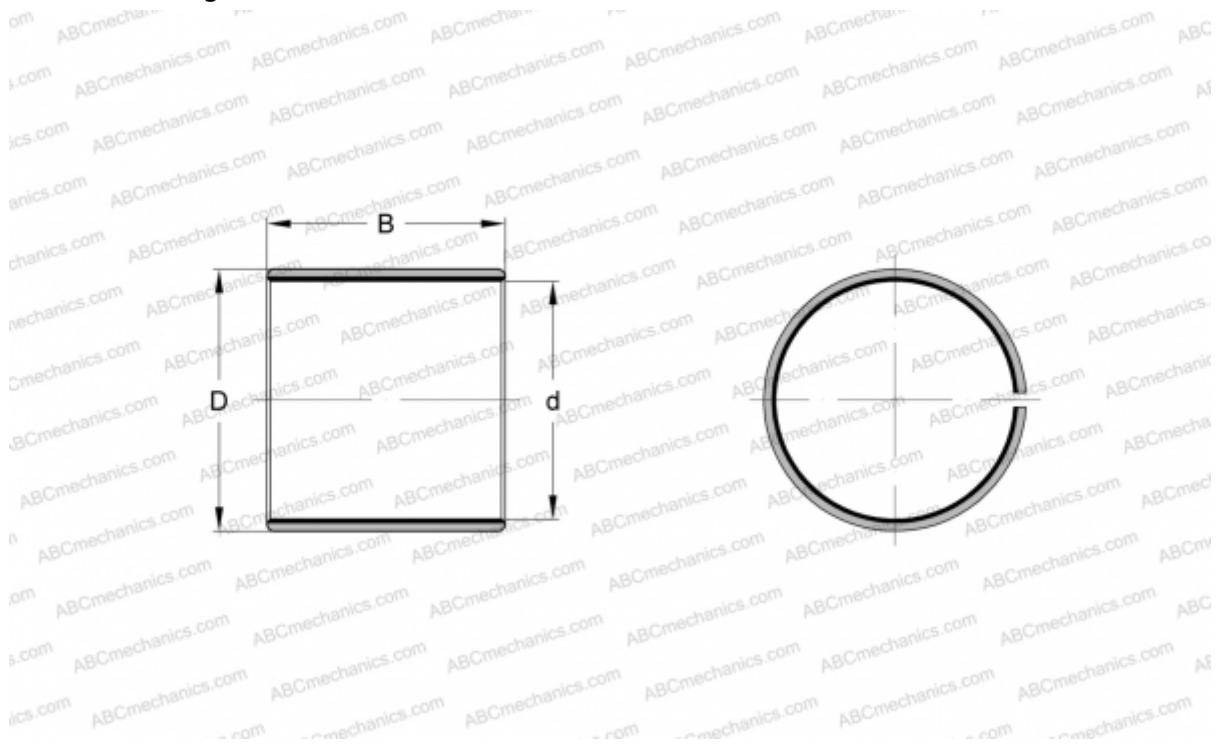

Technical specification

DIMENSIONS, MM

d	9,525
D	11,906
B	15,880

WEIGHT, KG 0,005

MANUFACTURER [INA](#)

REPLACES

PAPZ0610-P14