

EGBZ0906-E40 INA

Plain bushes

TYPE: Plain bearings, Bushings, thrust washers and strips, Bushings, Without flange, Maintenance-free, with steel backing, inch size (INA)

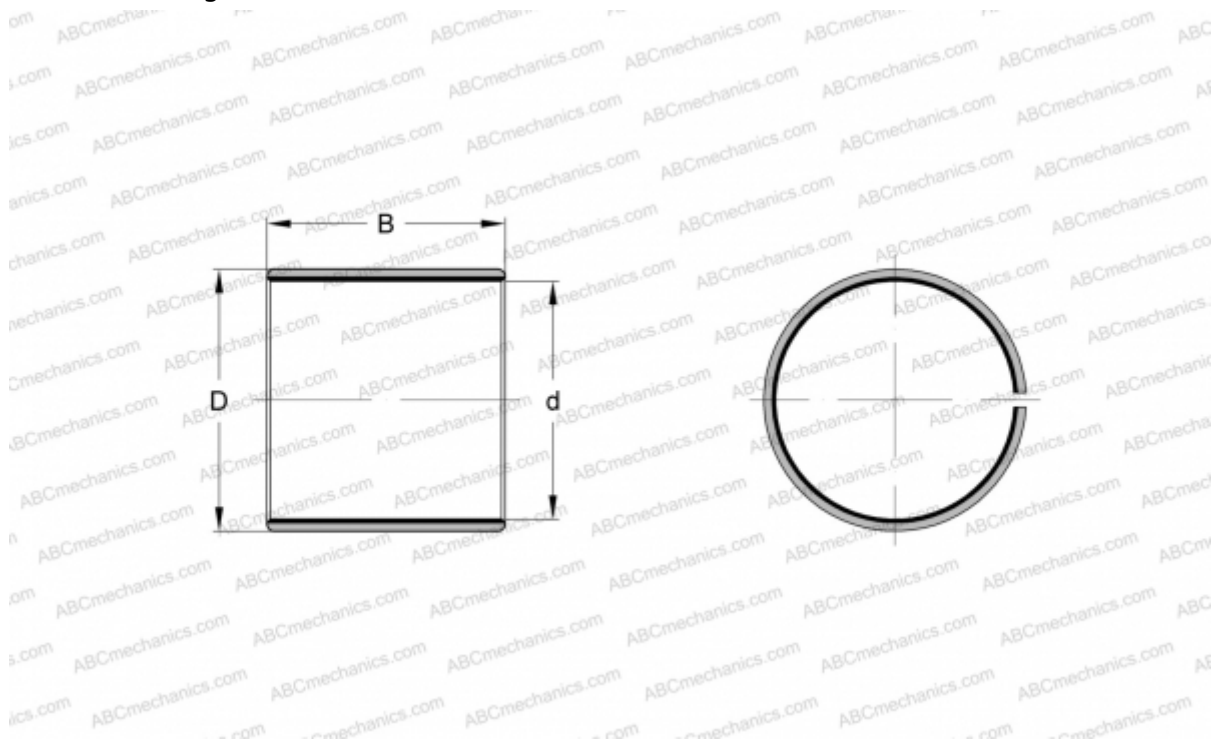

Technical specification

DIMENSIONS, MM

d	14,288
D	16,669
B	9,530

WEIGHT, KG 0,004

MANUFACTURER [INA](#)

REPLACES

PAPZ0906-P14