

EGBZ1010-E40 INA

Plain bushes

TYPE: Plain bearings, Bushings, thrust washers and strips, Bushings, Without flange, Maintenance-free, with steel backing, inch size (INA)

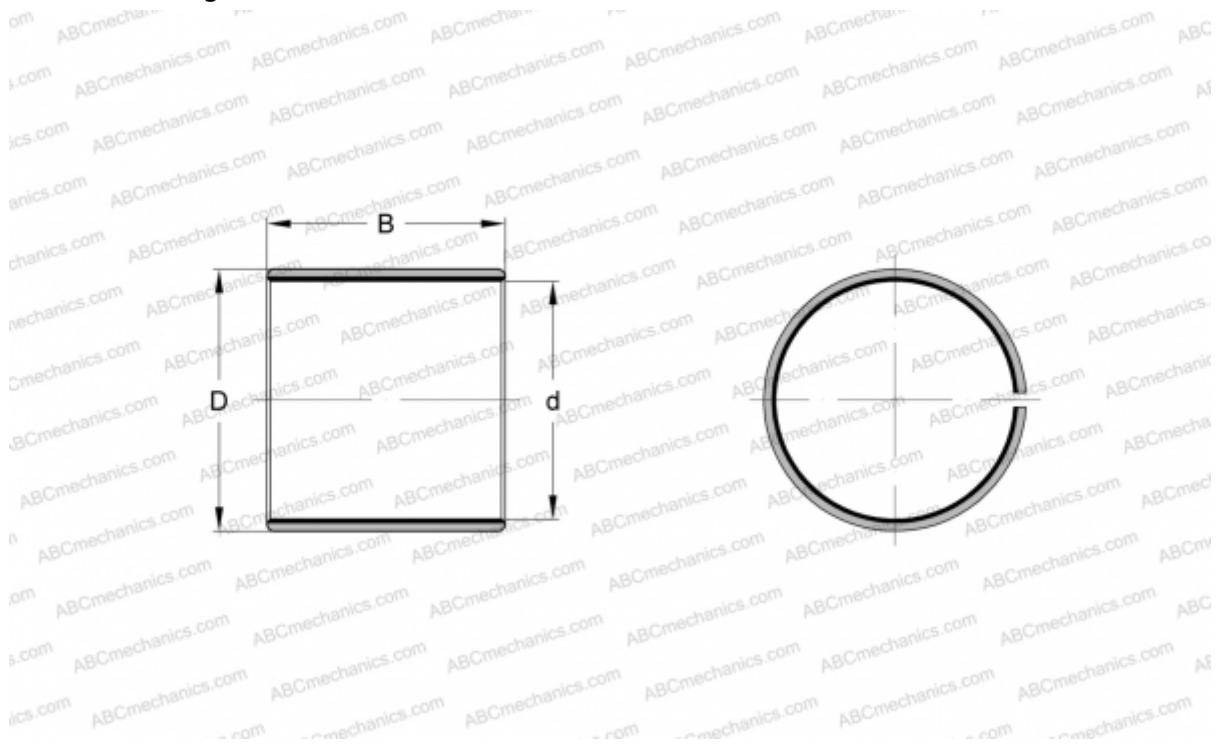

Technical specification

DIMENSIONS, MM

d	15,875
D	18,258
B	15,880

WEIGHT, KG 0,008

MANUFACTURER [INA](#)

REPLACES

PAPZ1010-P14