

EGBZ1206-E40 INA

Plain bushes

TYPE: Plain bearings, Bushings, thrust washers and strips, Bushings, Without flange, Maintenance-free, with steel backing, inch size (INA)

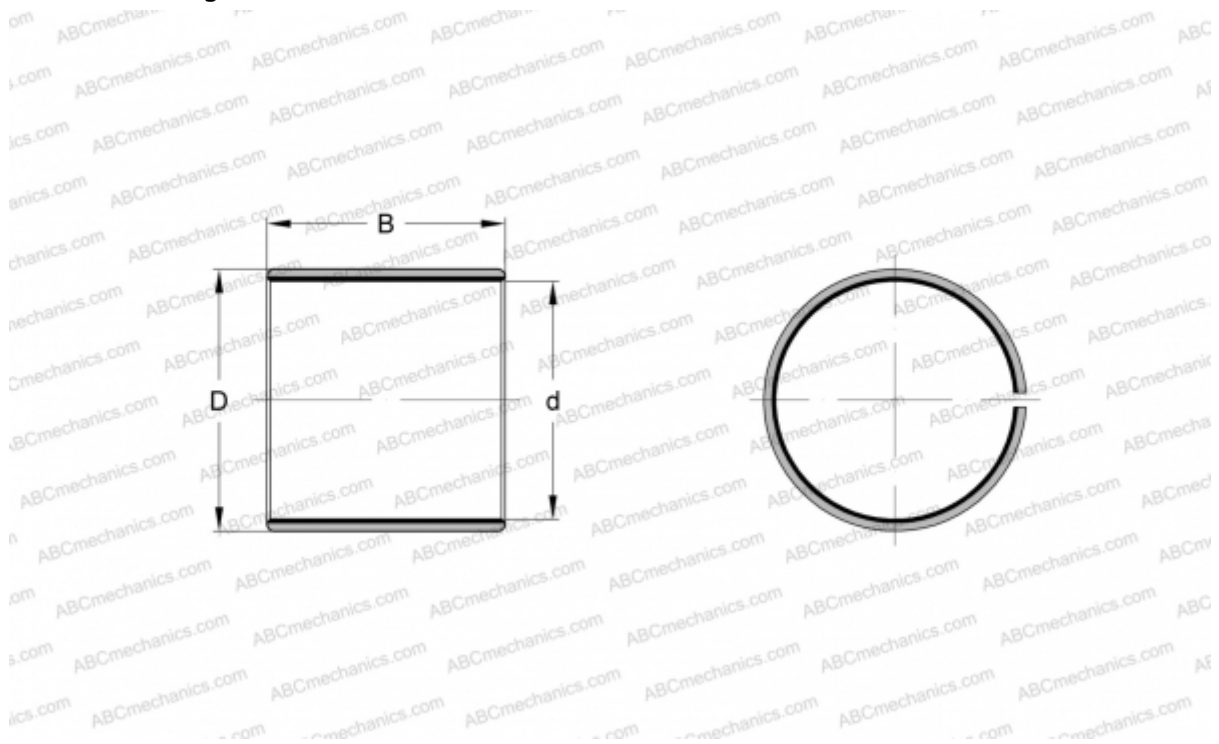

Technical specification

DIMENSIONS, MM

d	19,050
D	22,225
B	9,530

WEIGHT, KG 0,008

MANUFACTURER [INA](#)

REPLACES

PAPZ1206-P14