

EGBZ2616-E40 INA

Plain bushes

TYPE: Plain bearings, Bushings, thrust washers and strips, Bushings, Without flange, Maintenance-free, with steel backing, inch size (INA)

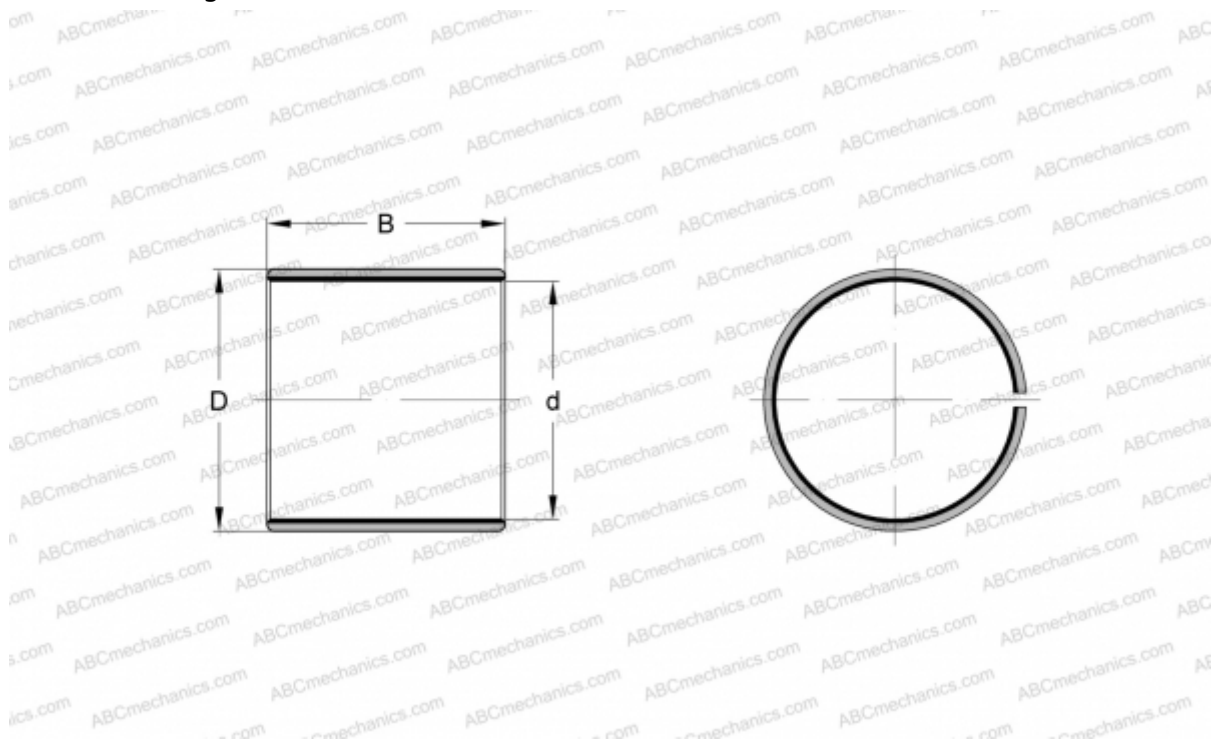

Technical specification

DIMENSIONS, MM

d	41,275
D	45,244
B	25,400

WEIGHT, KG 0,053

MANUFACTURER [INA](#)

REPLACES

PAPZ2616-P14