

ZWB354140 INA

Plain bushes

TYPE: Plain bearings, Bushings, thrust washers and strips, Bushings, Without flange, Cylindrical plain bushes, wound, with ELGOTEX, maintenance-free, wear-resistant (INA)

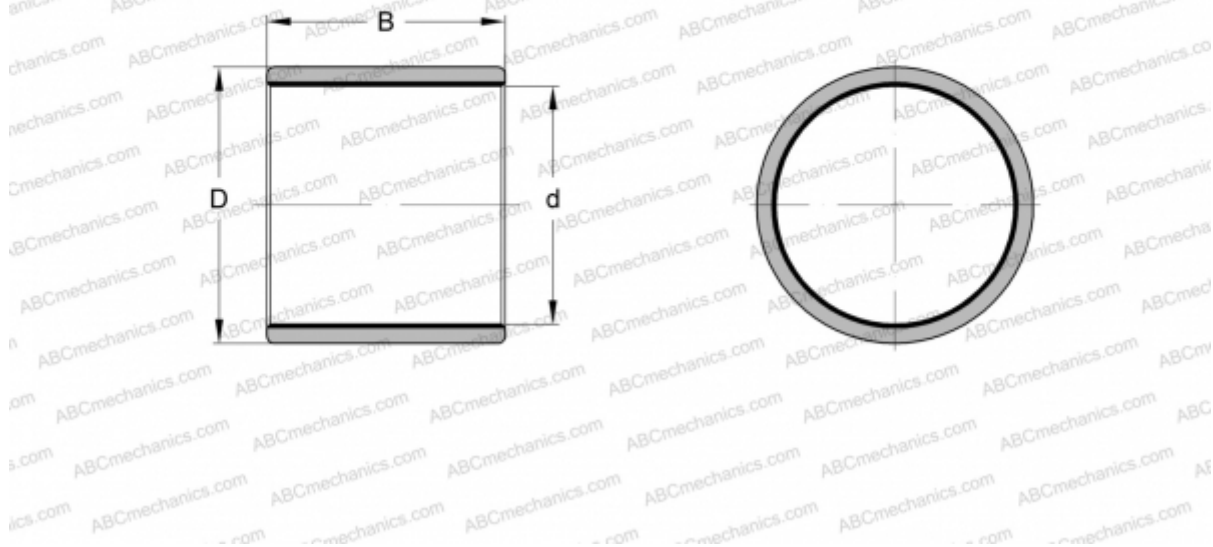

Technical specification

DIMENSIONS, MM

d	35,000
D	41,000
B	40,000

WEIGHT, KG 0,026

MANUFACTURER [INA](#)