

ZWB404830 INA

Plain bushes

TYPE: Plain bearings, Bushings, thrust washers and strips, Bushings, Without flange, Cylindrical plain bushes, wound, with ELGOTEX, maintenance-free, wear-resistant (INA)

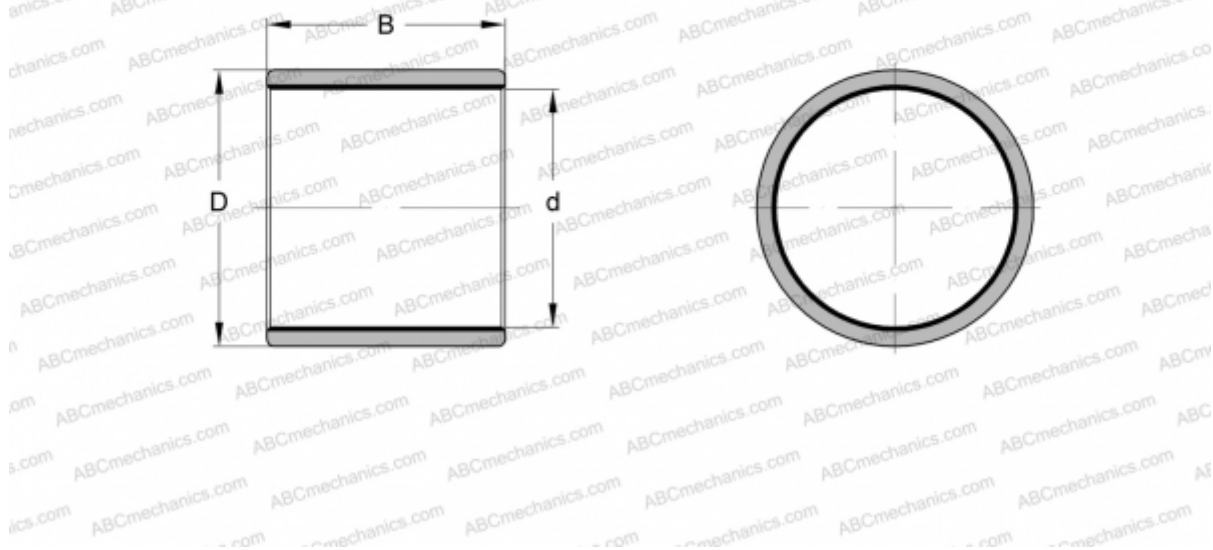

Technical specification

DIMENSIONS, MM

| | |
|---|--------|
| d | 40,000 |
| D | 48,000 |
| B | 30,000 |

WEIGHT, KG 0,030

MANUFACTURER [INA](#)