

ZWB140155100 INA

Plain bushes

TYPE: Plain bearings, Bushings, thrust washers and strips, Bushings, Without flange, Cylindrical plain bushes, wound, with ELGOTEX, maintenance-free, wear-resistant (INA)

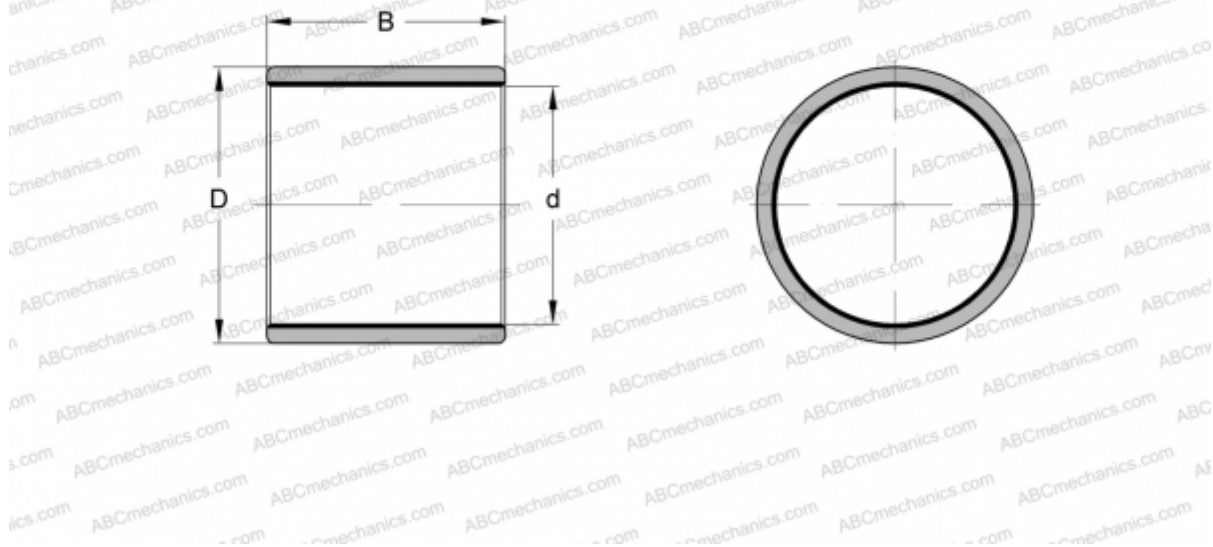

Technical specification

DIMENSIONS, MM

d	140,000
D	155,000
B	100,000

WEIGHT, KG 0,626

MANUFACTURER [INA](#)