

PCM 101220 E SKF

Plain bushes

TYPE: Plain bearings, Bushings, thrust washers and strips, Bushings, Without flange, Maintenance-free, PTFE composite (SKF)

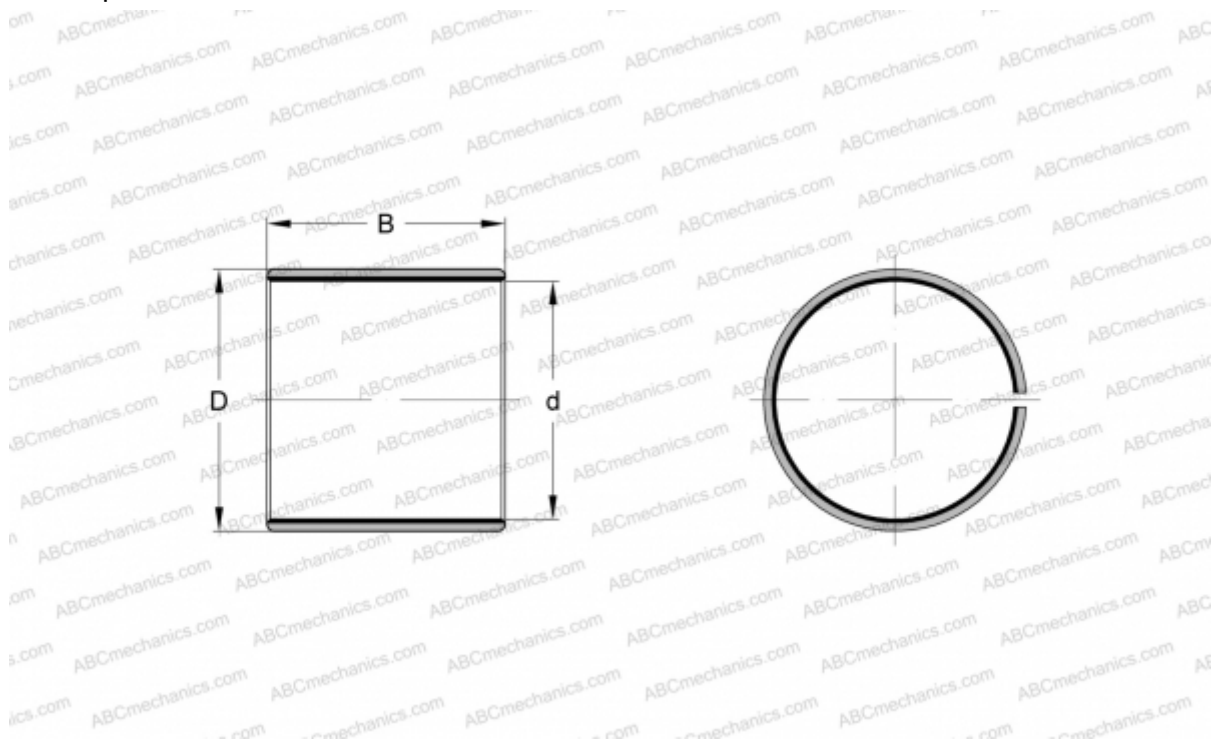

Technical specification

DIMENSIONS, MM

d	10,000
D	12,000
B	20,000

WEIGHT, KG 0,005

MANUFACTURER [SKF](#)

REPLACES

PCM 101220 B