

PCM 161810 E SKF

Plain bushes

TYPE: Plain bearings, Bushings, thrust washers and strips, Bushings, Without flange, Maintenance-free, PTFE composite (SKF)

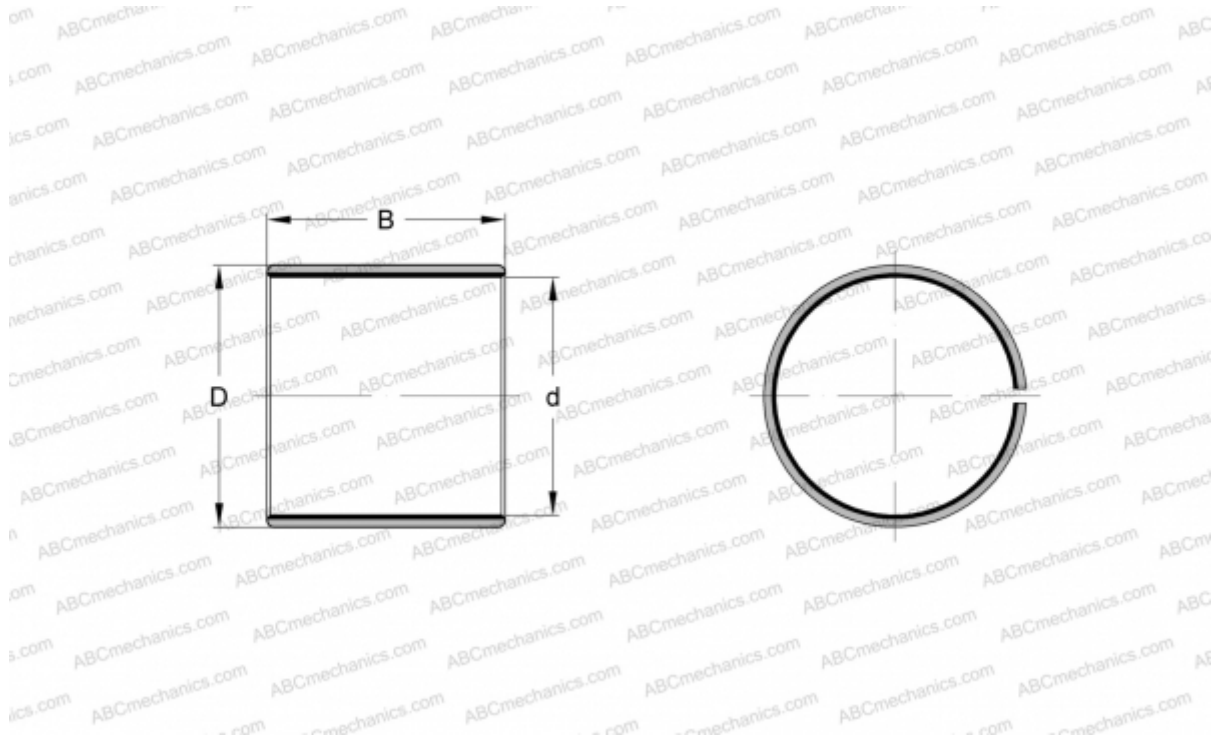

Technical specification

DIMENSIONS, MM

d	16,000
D	18,000
B	10,000

WEIGHT, KG 0,004

MANUFACTURER [SKF](#)

REPLACES

PCM 161810 B