

PCM 353930 E SKF

Plain bushes

TYPE: Plain bearings, Bushings, thrust washers and strips, Bushings, Without flange, Maintenance-free, PTFE composite (SKF)

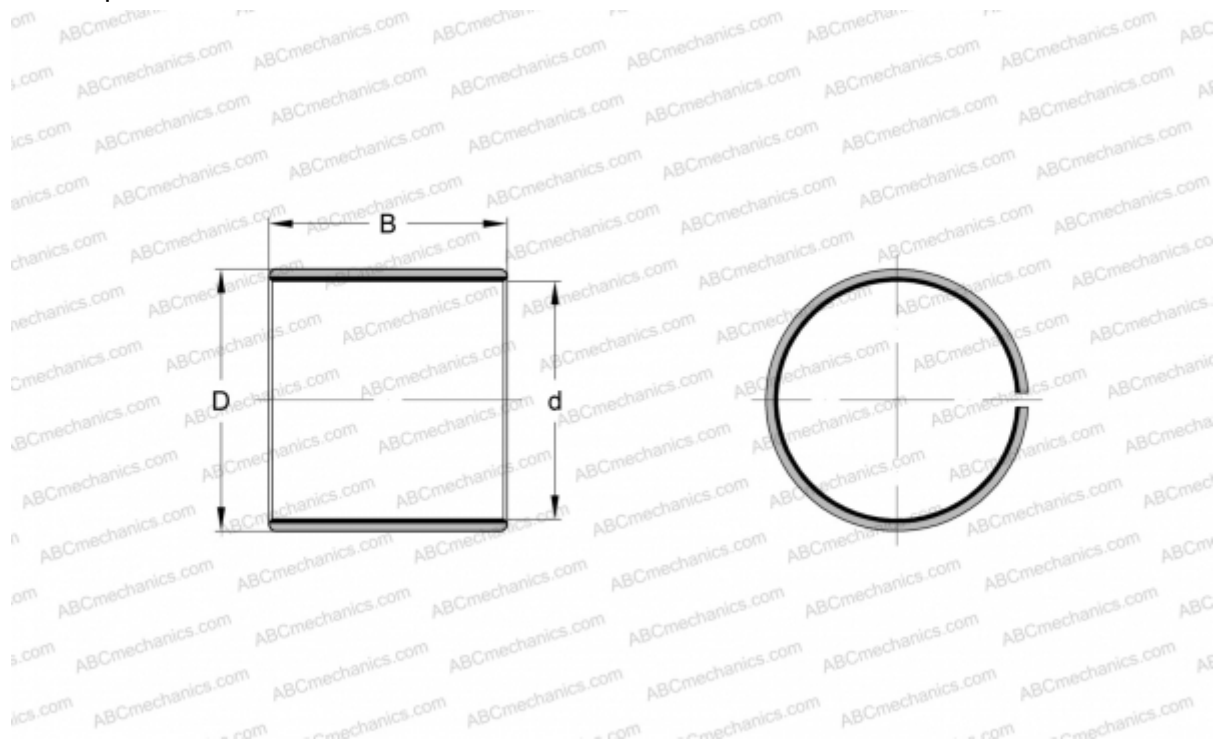

Technical specification

DIMENSIONS, MM

d	35,000
D	39,000
B	30,000

WEIGHT, KG 0,052

MANUFACTURER [SKF](#)

REPLACES

PCM 353930 B