

PCM 556025 E SKF

Plain bushes

TYPE: Plain bearings, Bushings, thrust washers and strips, Bushings, Without flange, Maintenance-free, PTFE composite (SKF)

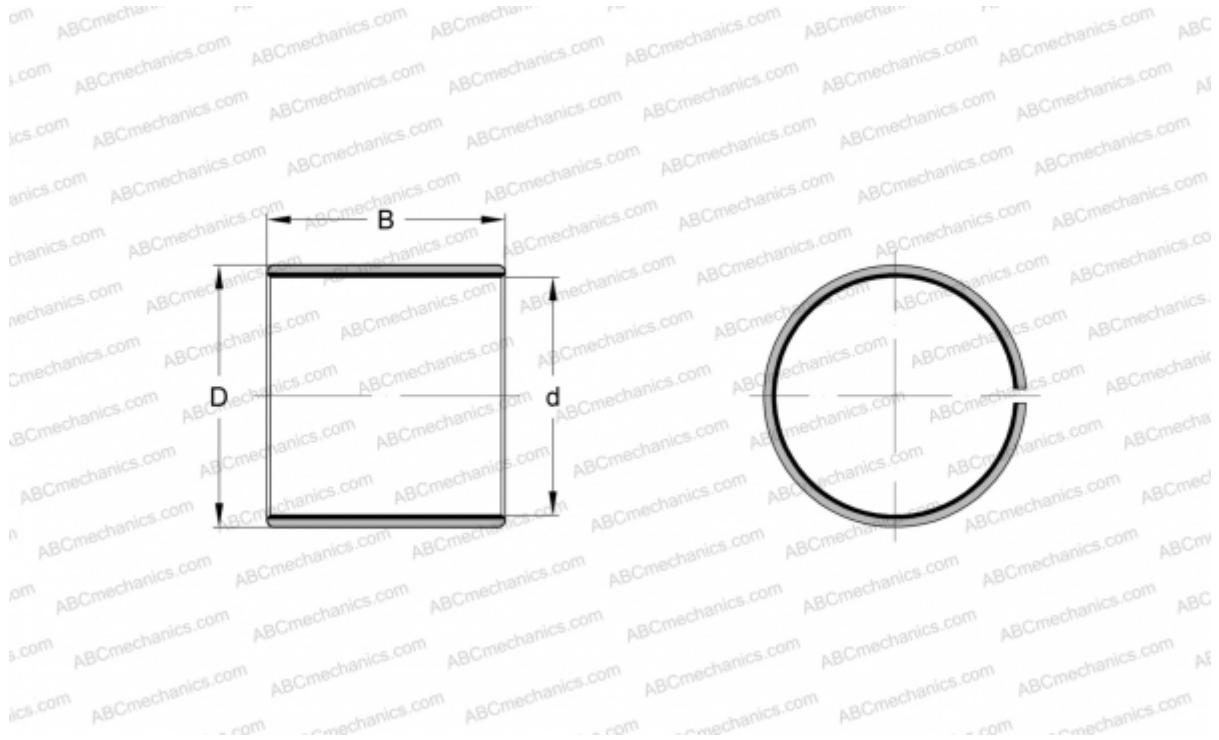

Technical specification

DIMENSIONS, MM

d	55,000
D	60,000
B	25,000

WEIGHT, KG 0,084

MANUFACTURER [SKF](#)

REPLACES

PCM 556025 B