

PCM 859030 E SKF

Plain bushes

TYPE: Plain bearings, Bushings, thrust washers and strips, Bushings, Without flange, Maintenance-free, PTFE composite (SKF)

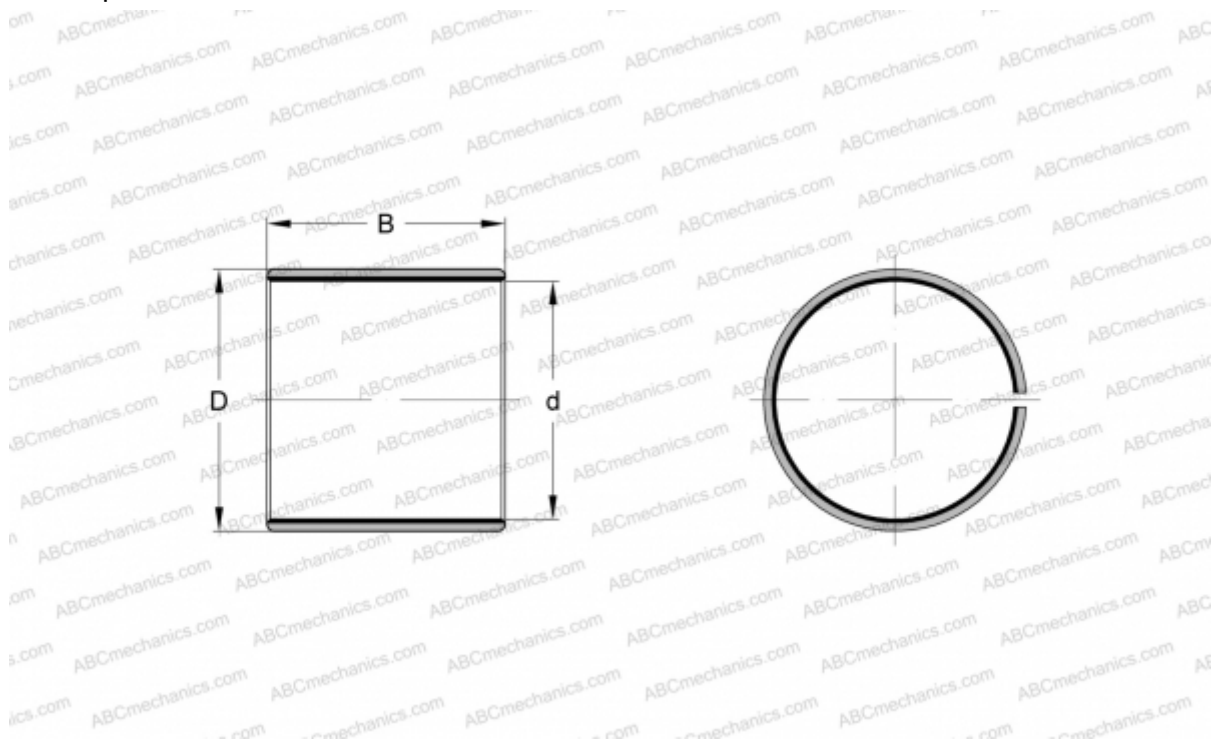

Technical specification

DIMENSIONS, MM

d	85,000
D	90,000
B	30,000

WEIGHT, KG 0,150

MANUFACTURER [SKF](#)

REPLACES

PCM 859030 B