

PCZ 3030 E SKF

Plain bushes

TYPE: Plain bearings, Bushings, thrust washers and strips, Bushings, Without flange, Maintenance-free, PTFE composite, inch size (SKF)

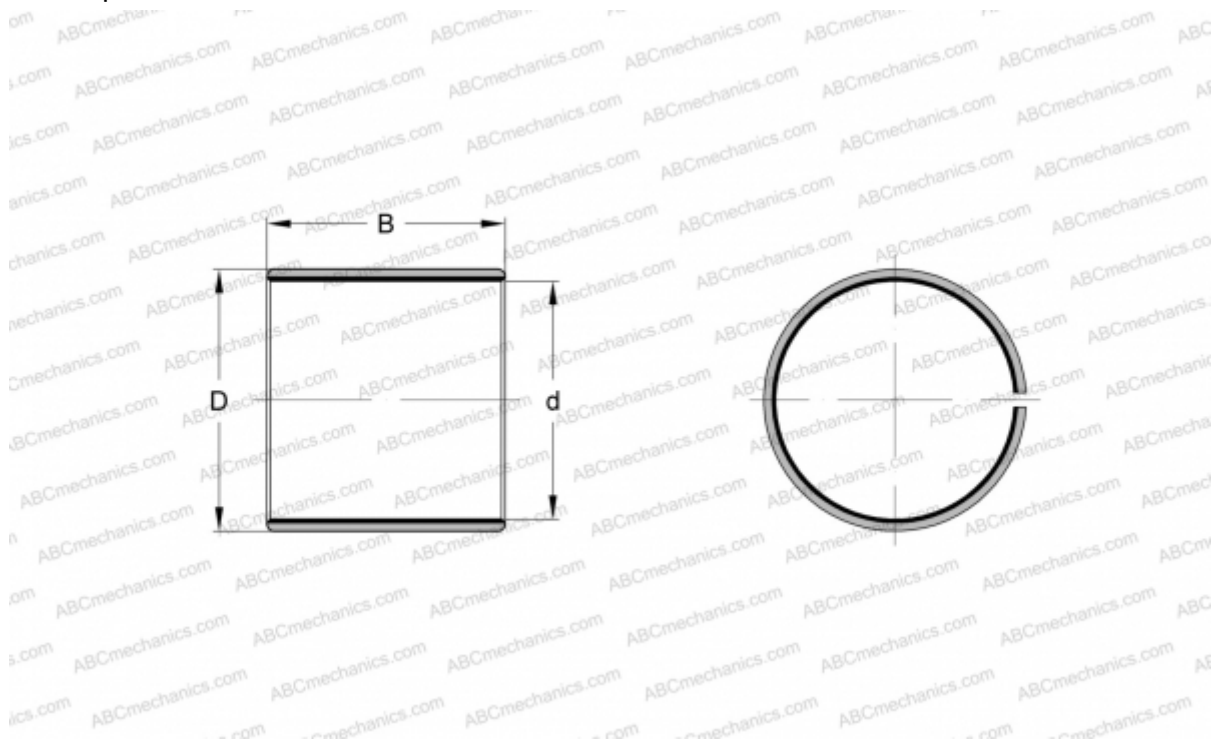

Technical specification

DIMENSIONS, MM

d	47,625
D	52,388
B	47,625

WEIGHT, KG 0,135

MANUFACTURER [SKF](#)

REPLACES

PCZ 3030 B