

PCZ 4432 E SKF

Plain bushes

TYPE: Plain bearings, Bushings, thrust washers and strips, Bushings, Without flange, Maintenance-free, PTFE composite, inch size (SKF)

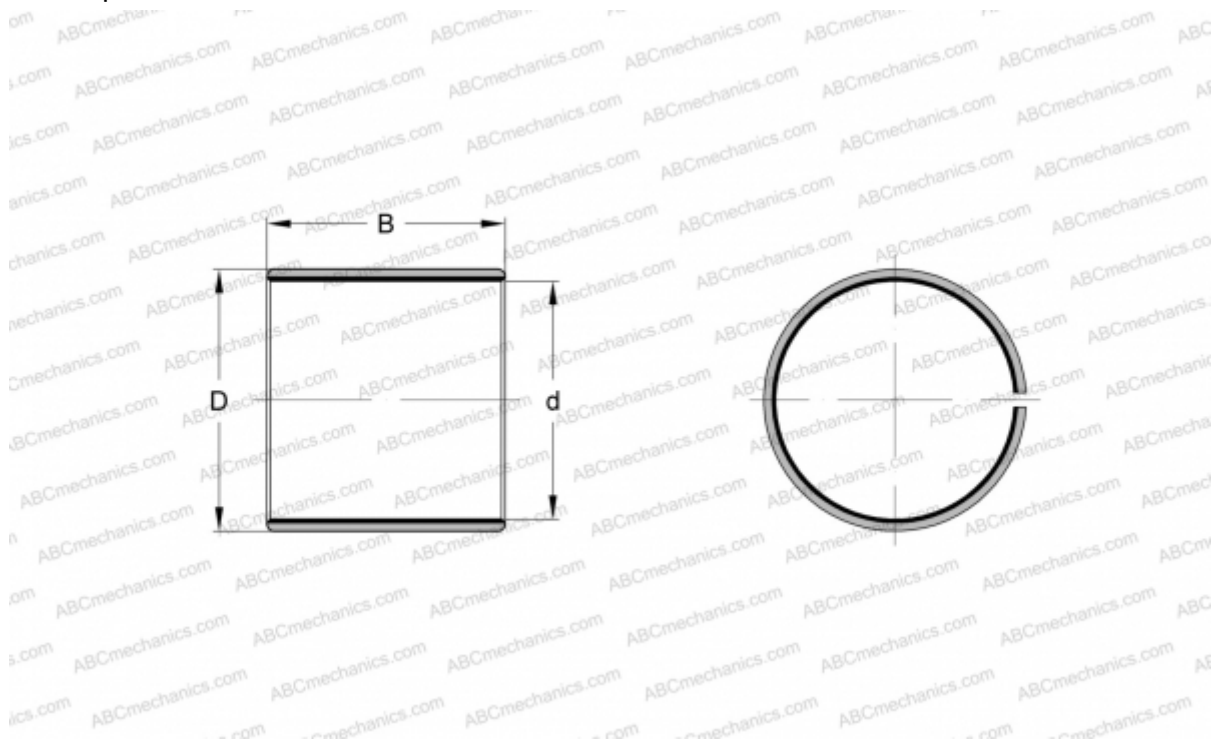

Technical specification

DIMENSIONS, MM

d	69,850
D	74,613
B	50,800

WEIGHT, KG 0,210

MANUFACTURER [SKF](#)

REPLACES

PCZ 4432 B