

PRM 151725 SKF

Plain bushes

TYPE: Plain bearings, Bushings, thrust washers and strips, Bushings, Without flange, Wrapped bronze (SKF)

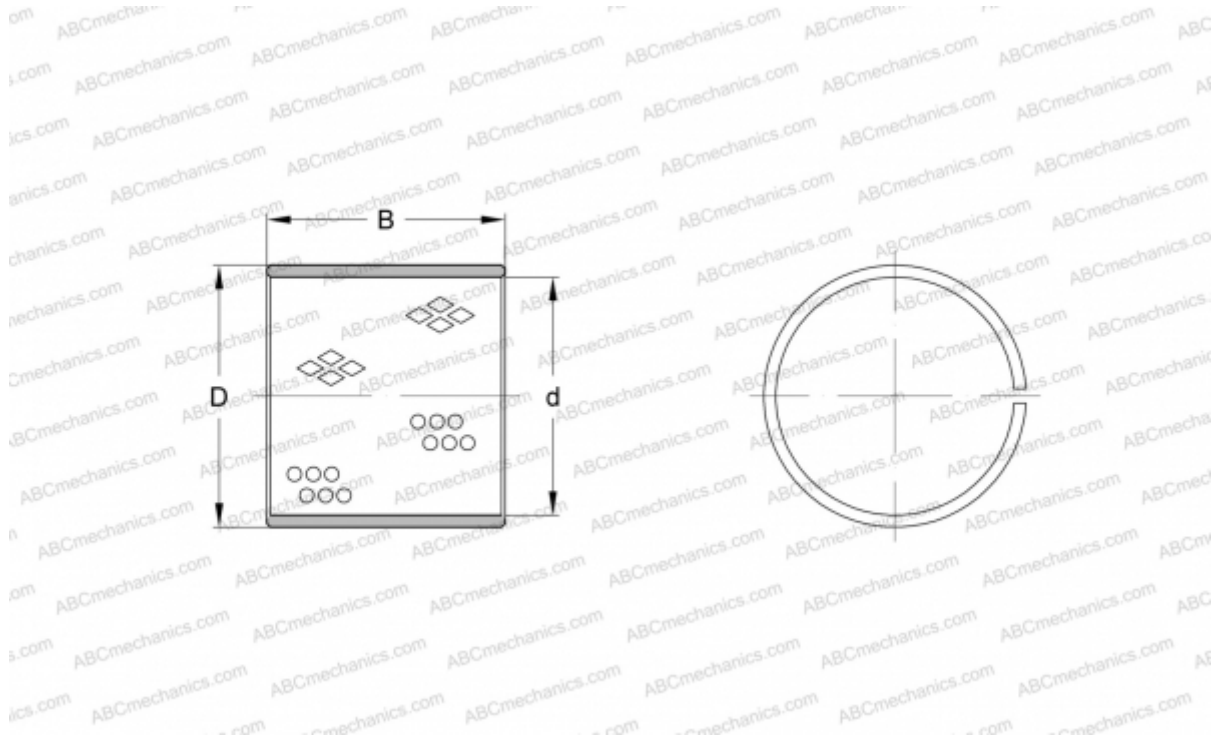

Technical specification

DIMENSIONS, MM

d	15,000
D	17,000
B	25,000

MANUFACTURER

[SKF](#)