

PRM 161820 SKF

Plain bushes

TYPE: Plain bearings, Bushings, thrust washers and strips, Bushings, Without flange, Wrapped bronze (SKF)

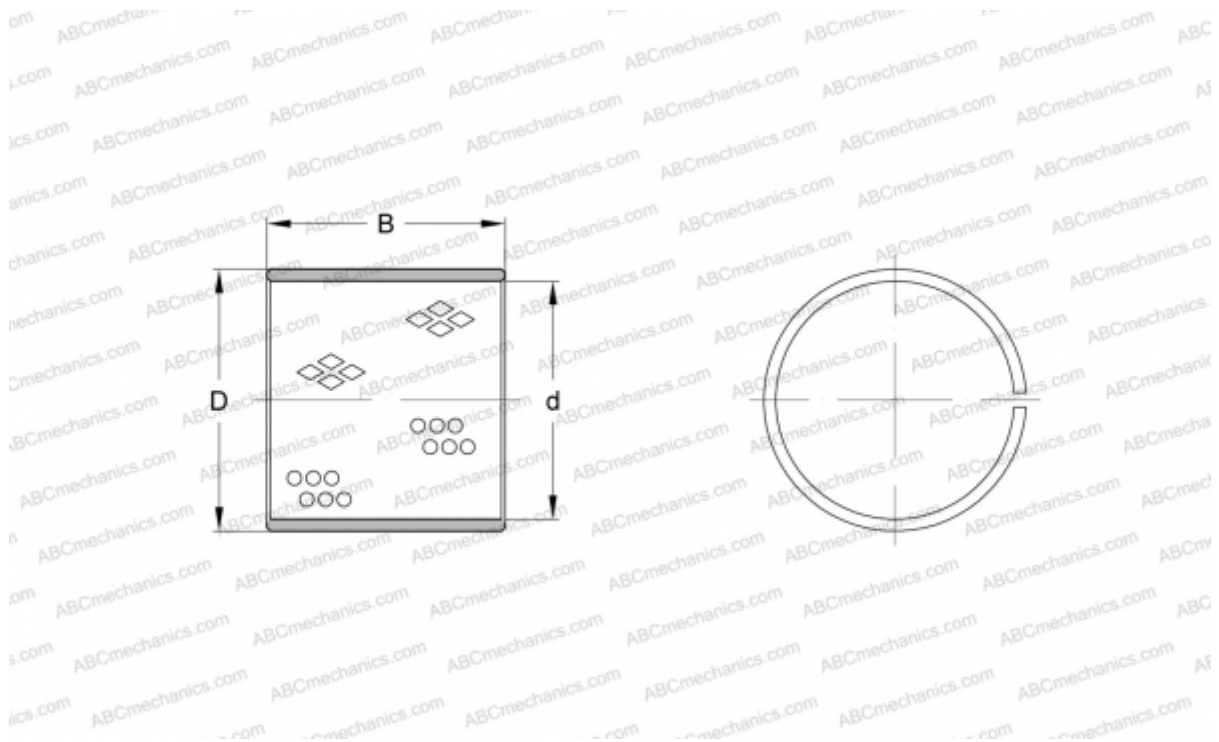

Technical specification

DIMENSIONS, MM

d	16,000
D	18,000
B	20,000

MANUFACTURER

[SKF](#)