

PRM 182115 SKF

Plain bushes

TYPE: Plain bearings, Bushings, thrust washers and strips, Bushings, Without flange, Wrapped bronze (SKF)

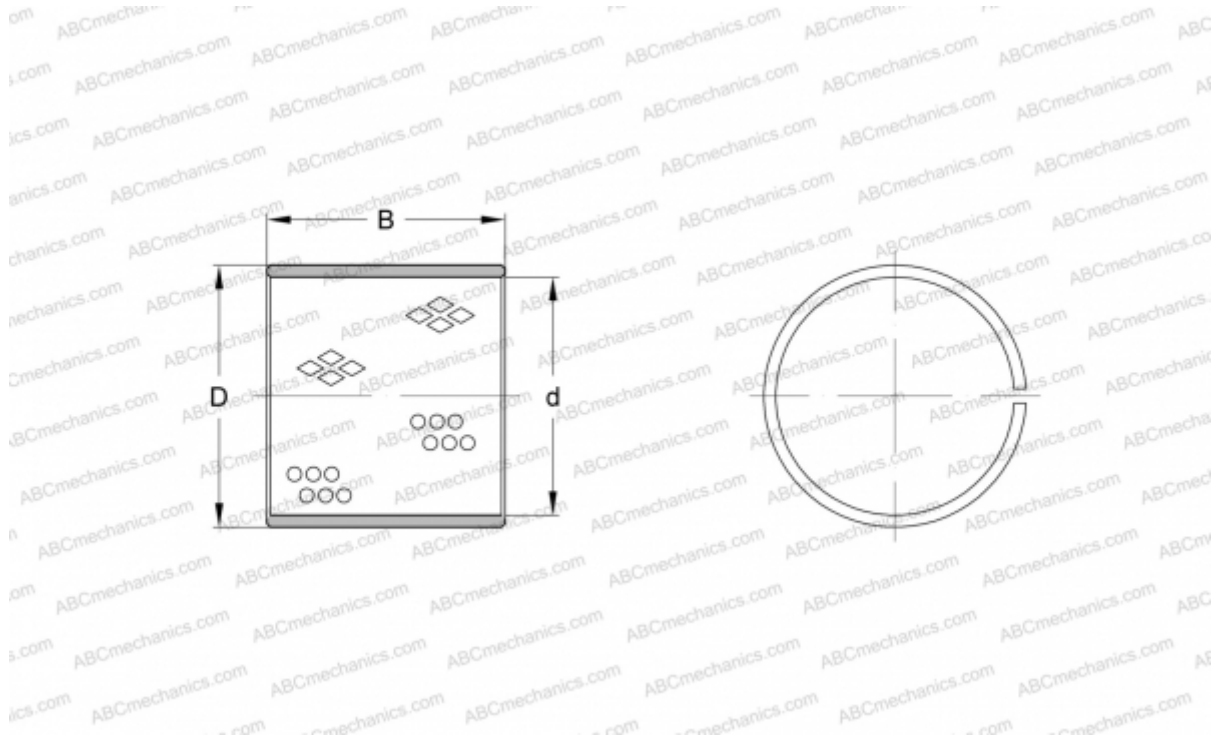

Technical specification

DIMENSIONS, MM

d	18,000
D	21,000
B	15,000

MANUFACTURER

[SKF](#)