

PRM 252830 SKF

Plain bushes

TYPE: Plain bearings, Bushings, thrust washers and strips, Bushings, Without flange, Wrapped bronze (SKF)

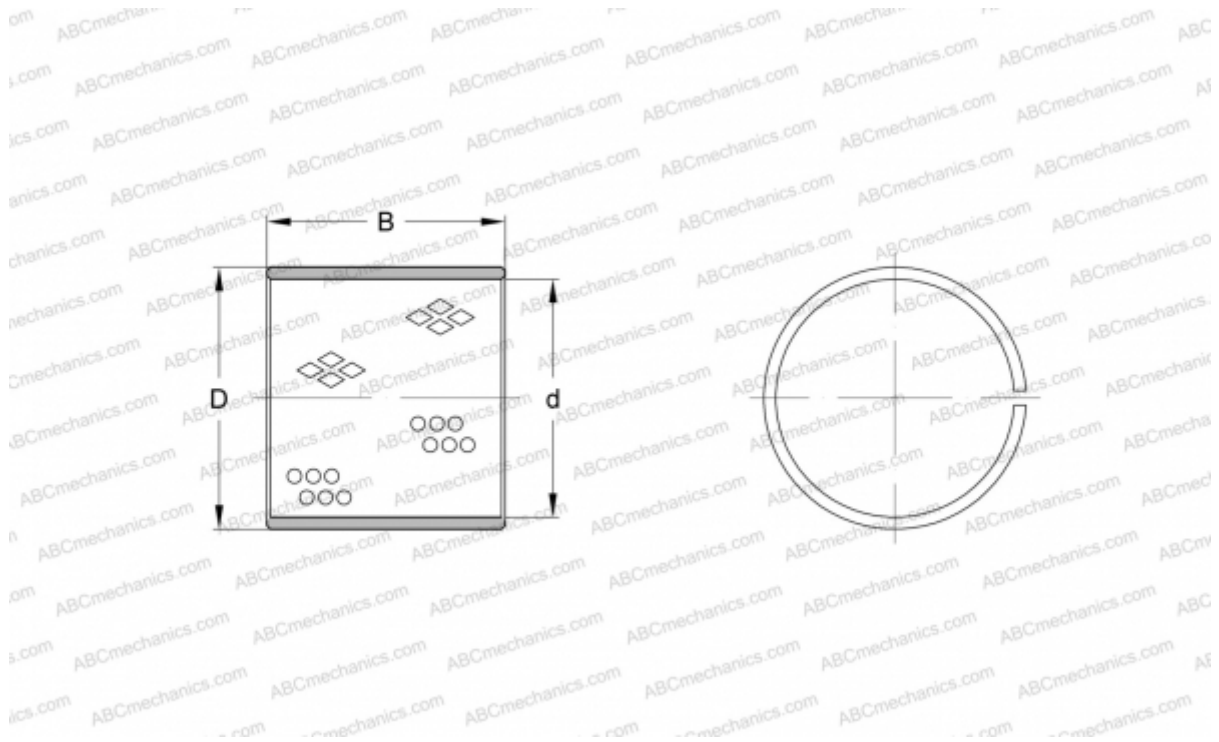

Technical specification

DIMENSIONS, MM

d	25,000
D	28,000
B	30,000

MANUFACTURER

[SKF](#)