

PRM 353940 SKF

Plain bushes

TYPE: Plain bearings, Bushings, thrust washers and strips, Bushings, Without flange, Wrapped bronze (SKF)

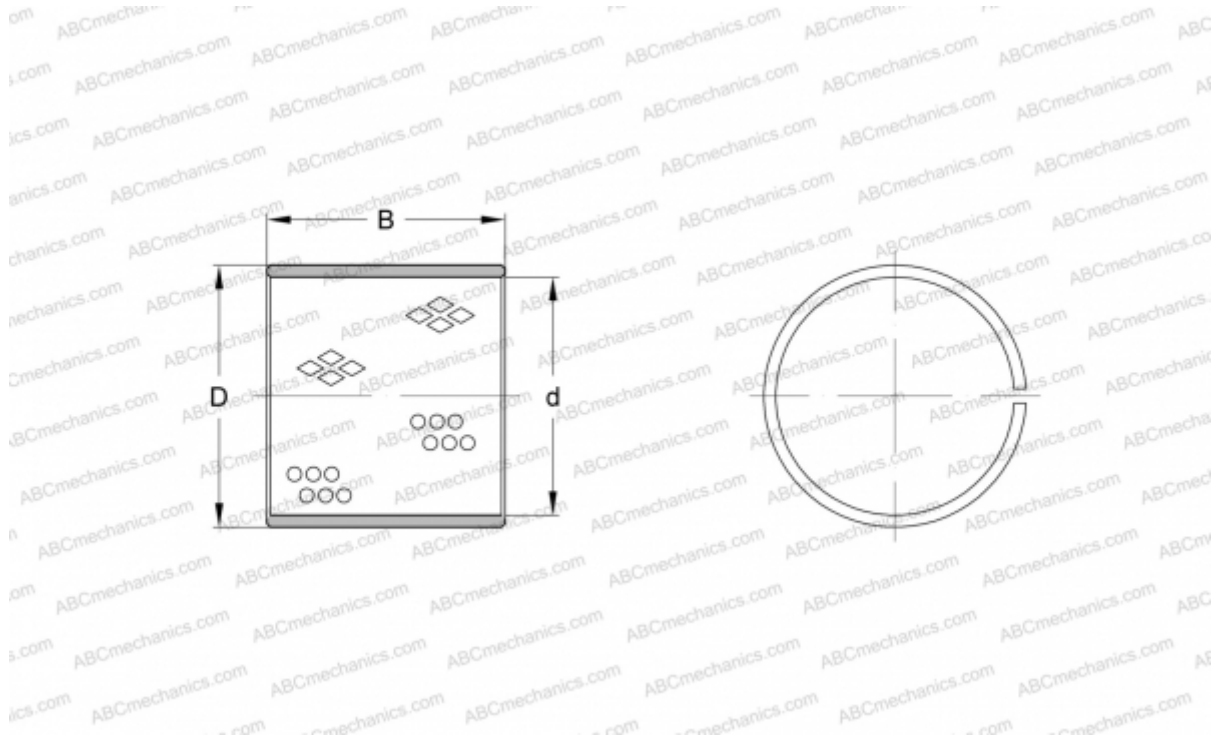

Technical specification

DIMENSIONS, MM

d	35,000
D	39,000
B	40,000

MANUFACTURER

[SKF](#)