

PRM 40430 SKF

Plain bushes

TYPE: Plain bearings, Bushings, thrust washers and strips, Bushings, Without flange, Wrapped bronze (SKF)

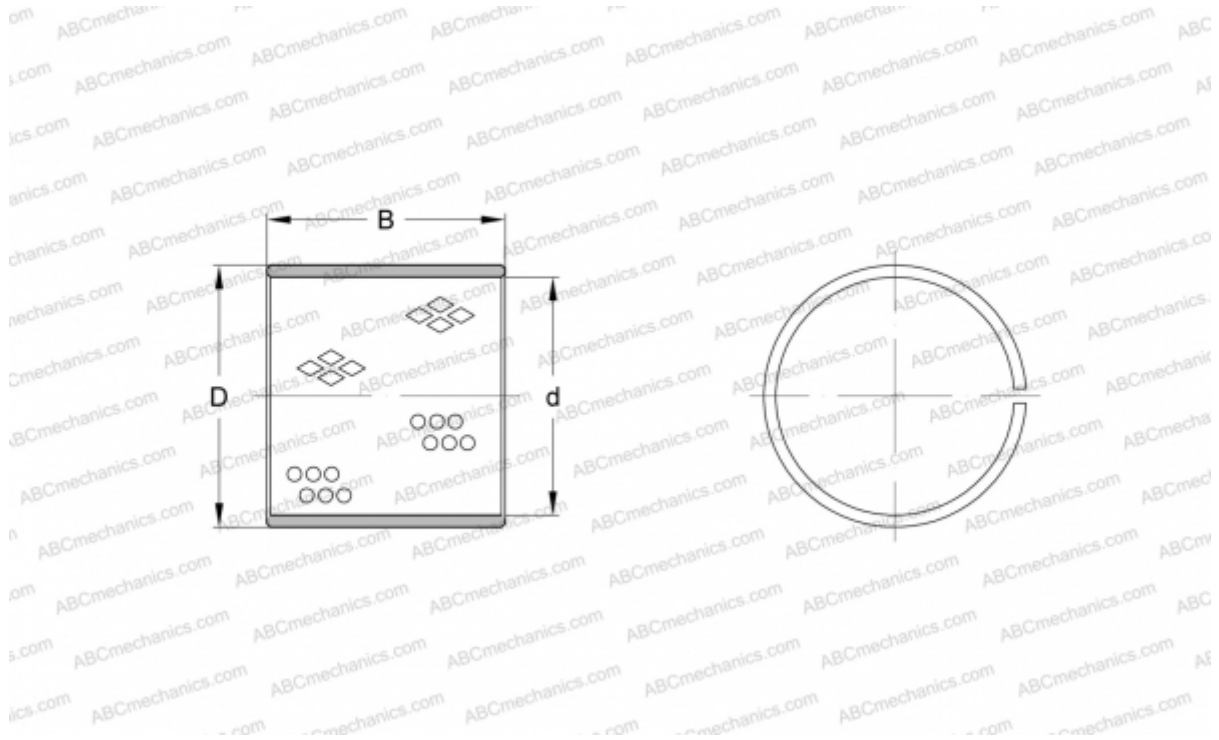

Technical specification

DIMENSIONS, MM

d	40,000
D	44,000
B	30,000

MANUFACTURER

[SKF](#)