

PRM 707580 SKF

Plain bushes

TYPE: Plain bearings, Bushings, thrust washers and strips, Bushings, Without flange, Wrapped bronze (SKF)

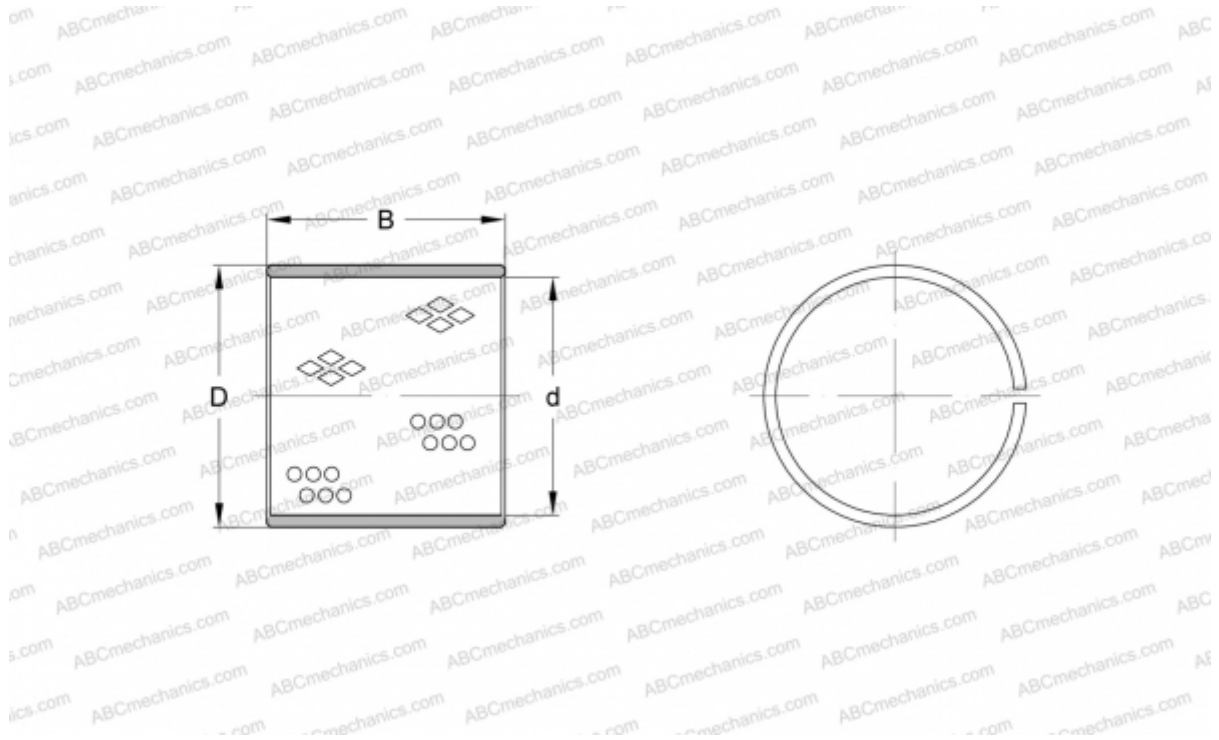

Technical specification

DIMENSIONS, MM

d	70,000
D	75,000
B	80,000

MANUFACTURER

[SKF](#)