

PRM 758080 SKF

Plain bushes

TYPE: Plain bearings, Bushings, thrust washers and strips, Bushings, Without flange, Wrapped bronze (SKF)

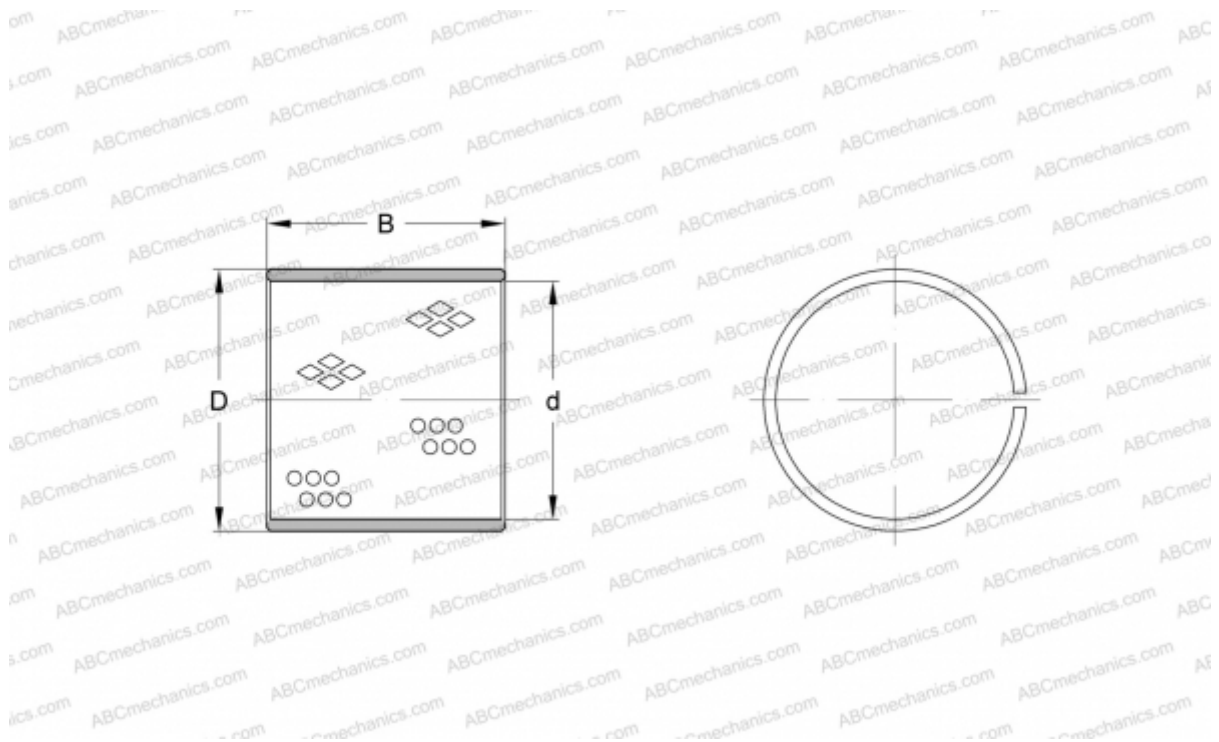

Technical specification

DIMENSIONS, MM

d	75,000
D	80,000
B	80,000

MANUFACTURER

[SKF](#)