

## PWM 202415 SKF

Plain bushes

TYPE: Plain bearings, Bushings, thrust washers and strips, Bushings, Without flange, Filament wound (SKF)

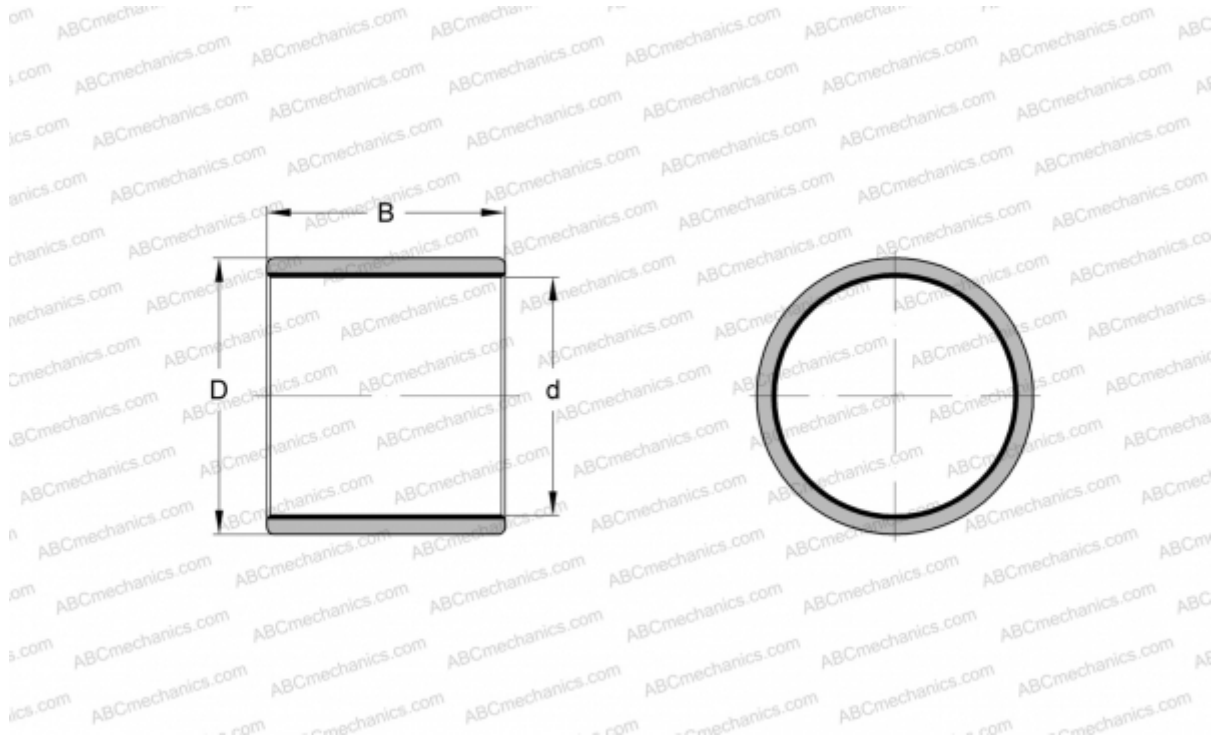

### Technical specification

#### DIMENSIONS, MM

d	20,000
D	24,000
B	15,000

#### MANUFACTURER

[SKF](#)