

## PWM 253030 SKF

Plain bushes

TYPE: Plain bearings, Bushings, thrust washers and strips, Bushings, Without flange, Filament wound (SKF)

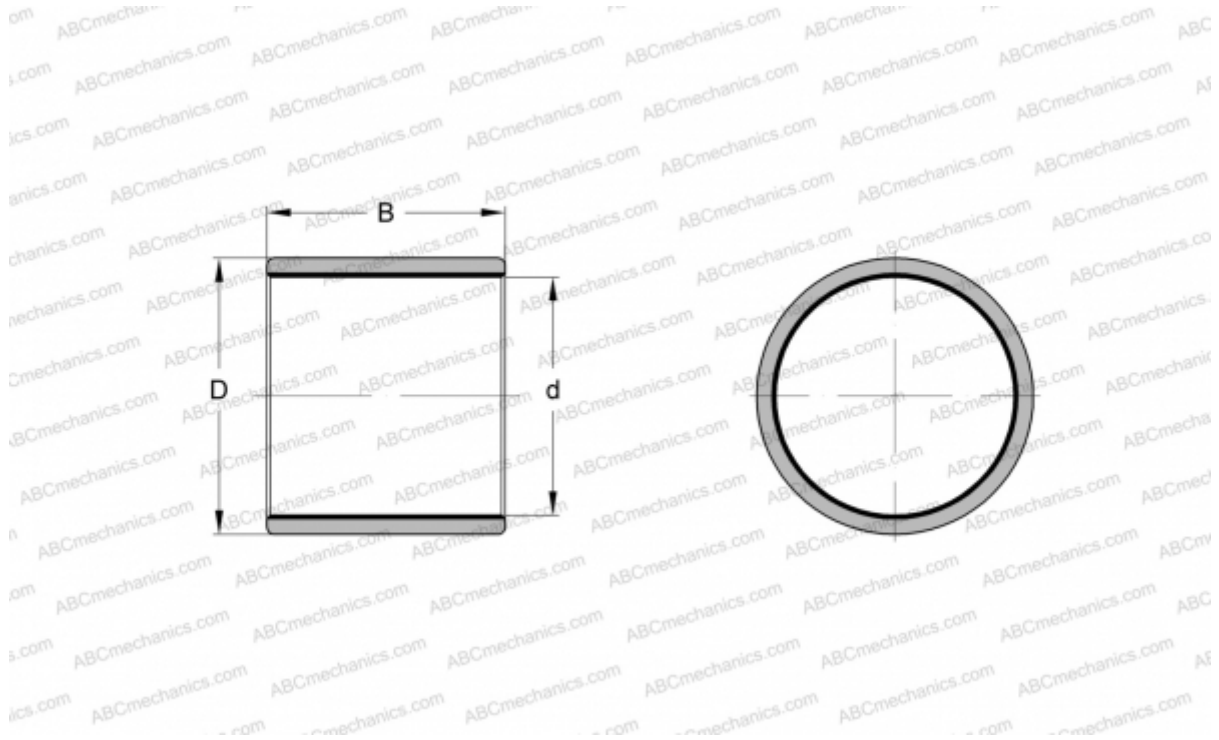

### Technical specification

#### DIMENSIONS, MM

|   |        |
|---|--------|
| d | 25,000 |
| D | 30,000 |
| B | 30,000 |

#### MANUFACTURER

[SKF](#)