

PWM 303620 SKF

Plain bushes

TYPE: Plain bearings, Bushings, thrust washers and strips, Bushings, Without flange, Filament wound (SKF)

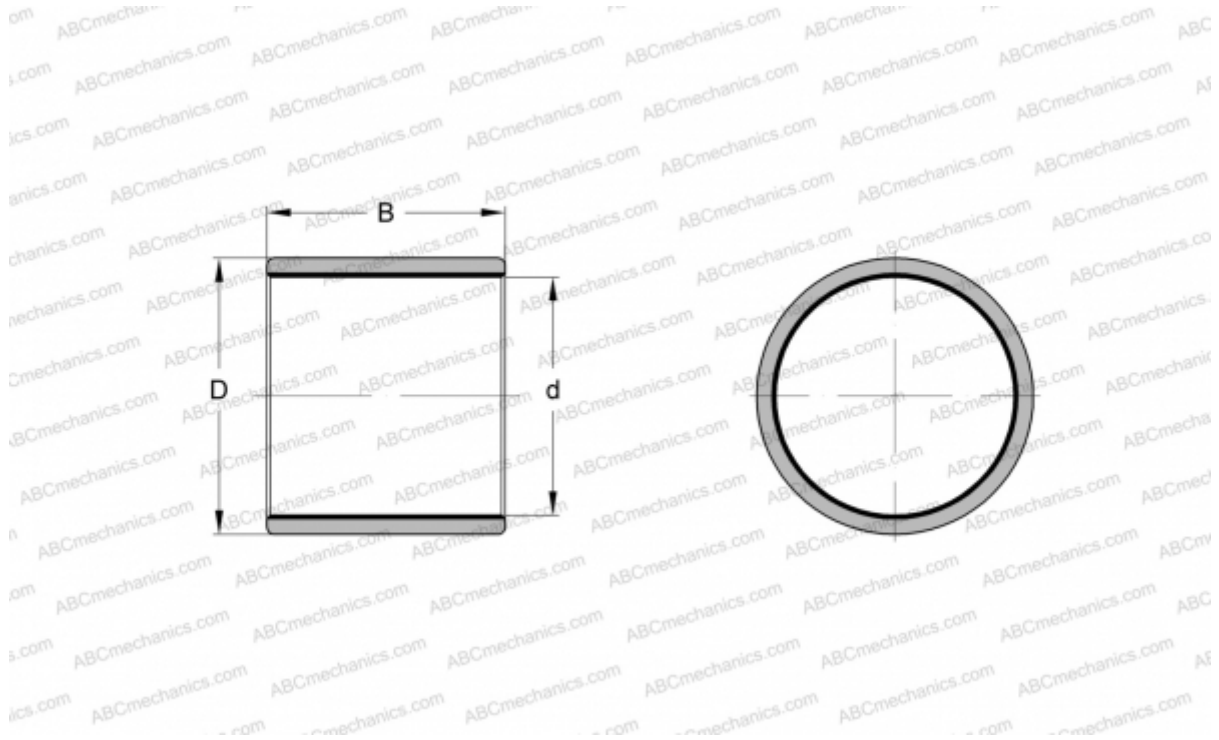

Technical specification

DIMENSIONS, MM

d	30,000
D	36,000
B	20,000

MANUFACTURER

[SKF](#)