

PWM 404840 SKF

Plain bushes

TYPE: Plain bearings, Bushings, thrust washers and strips, Bushings, Without flange, Filament wound (SKF)

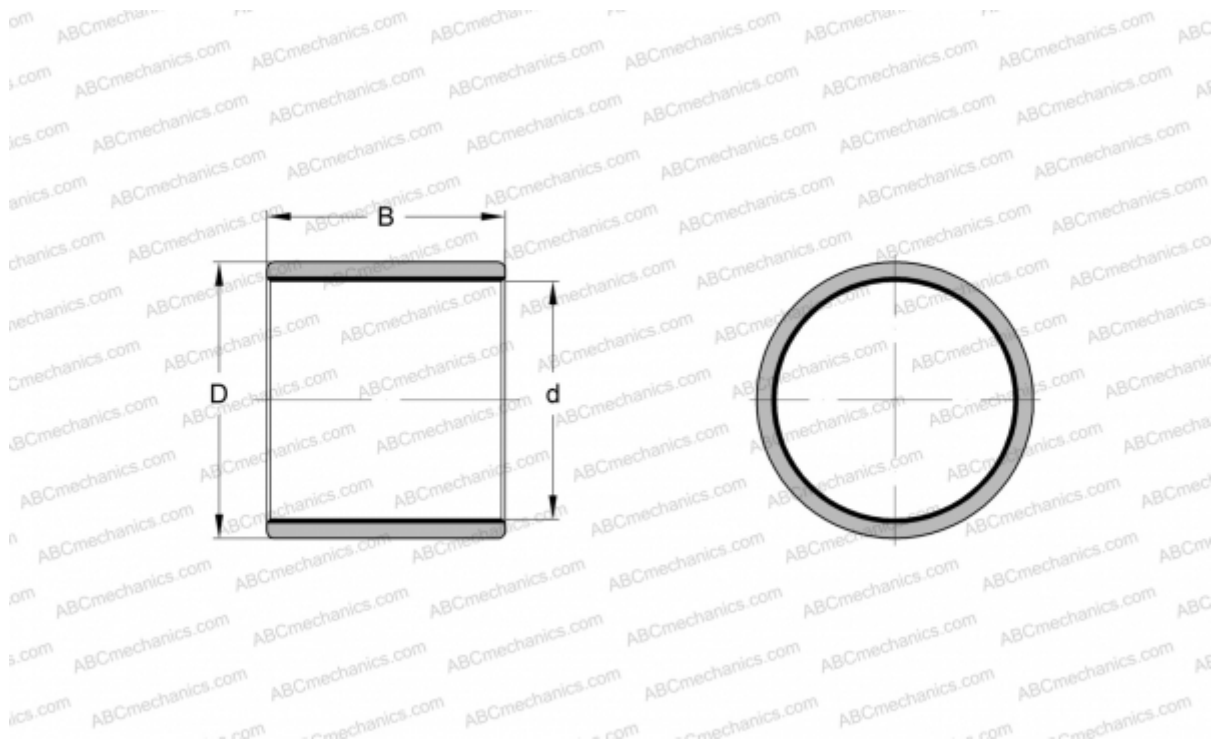

Technical specification

DIMENSIONS, MM

d	40,000
D	48,000
B	40,000

MANUFACTURER

[SKF](#)