

## PWM 404860 SKF

Plain bushes

TYPE: Plain bearings, Bushings, thrust washers and strips, Bushings, Without flange, Filament wound (SKF)

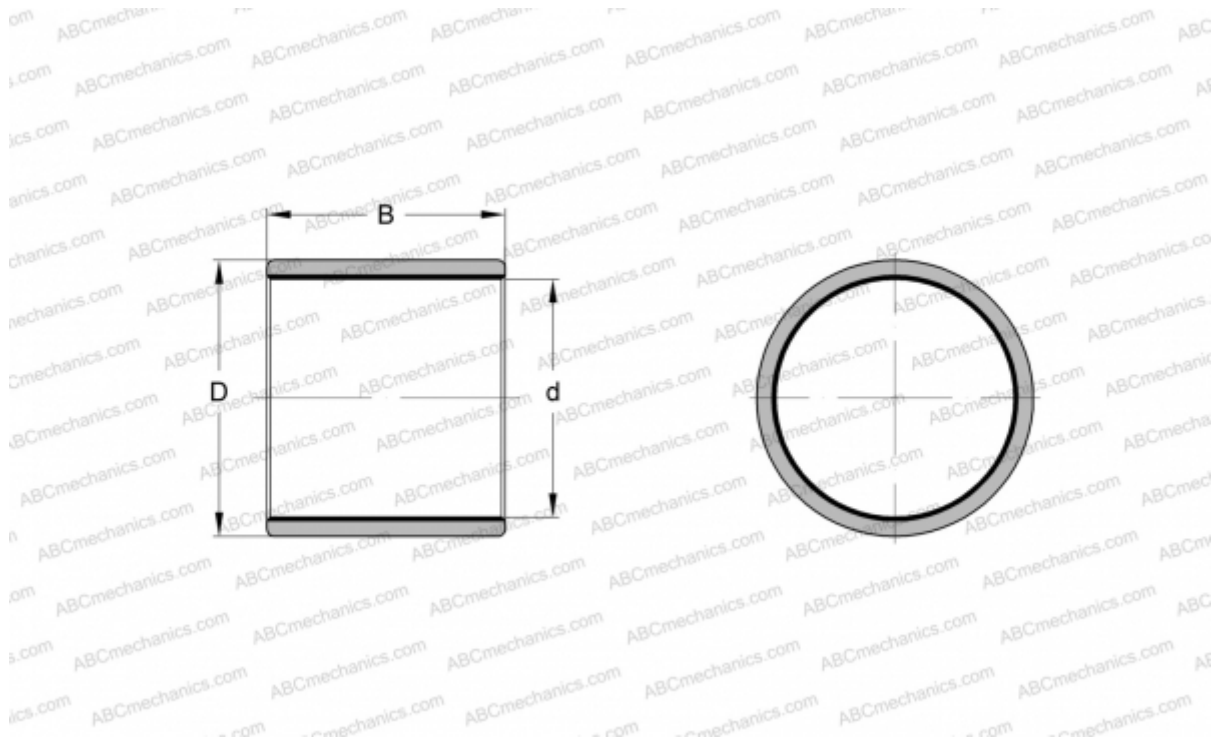

### Technical specification

#### DIMENSIONS, MM

d	40,000
D	48,000
B	60,000

#### MANUFACTURER

[SKF](#)