

PWM 455340 SKF

Plain bushes

TYPE: Plain bearings, Bushings, thrust washers and strips, Bushings, Without flange, Filament wound (SKF)

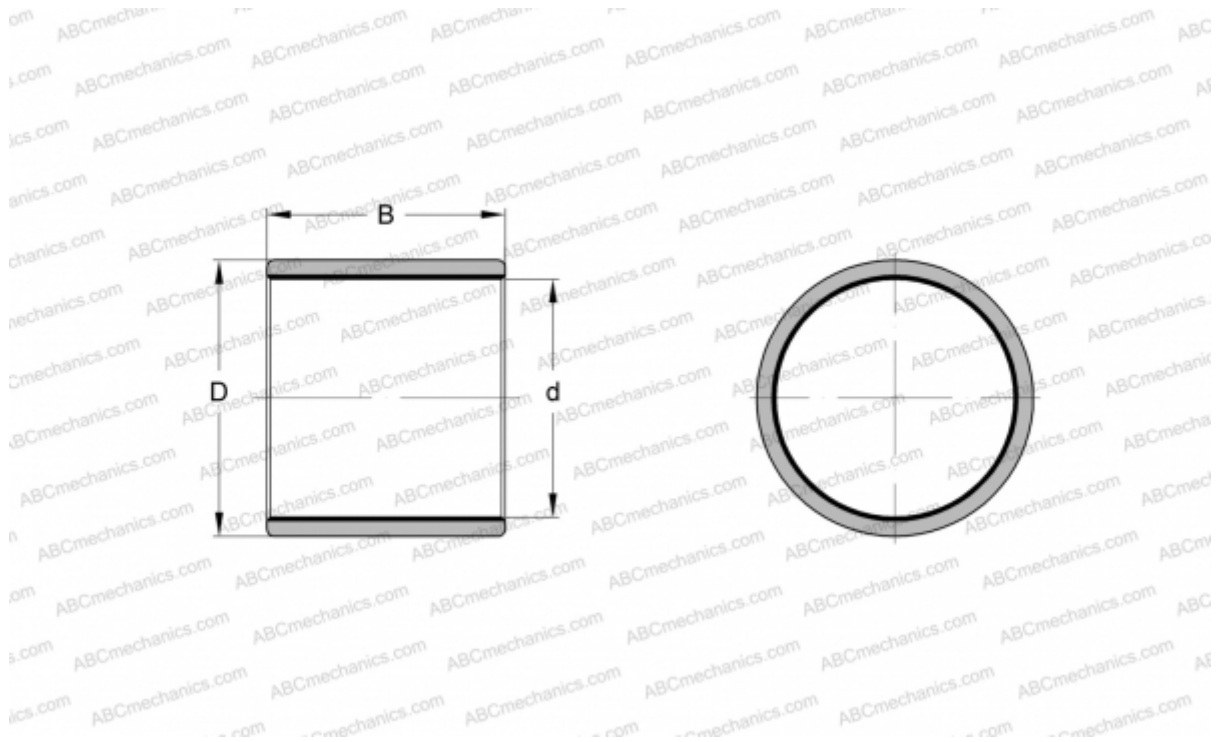

Technical specification

DIMENSIONS, MM

d	45,000
D	53,000
B	40,000

MANUFACTURER

[SKF](#)