

PWM 505850 SKF

Plain bushes

TYPE: Plain bearings, Bushings, thrust washers and strips, Bushings, Without flange, Filament wound (SKF)

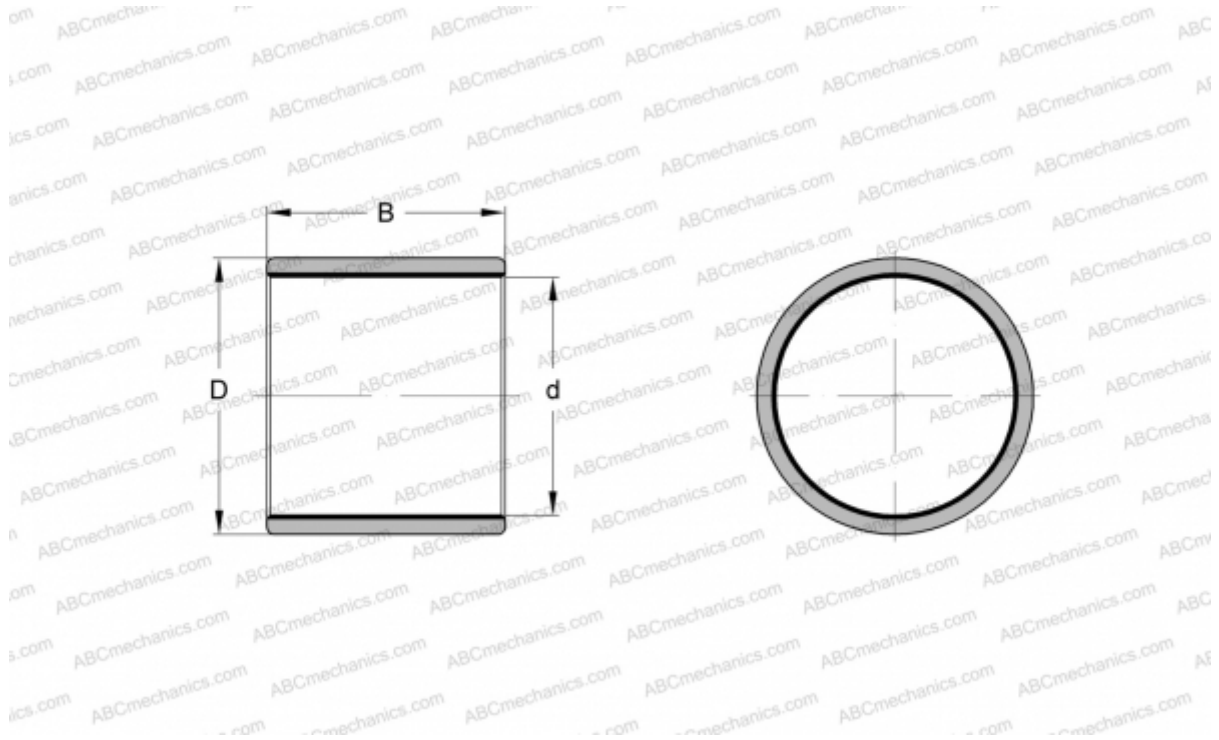

Technical specification

DIMENSIONS, MM

d	50,000
D	58,000
B	50,000

MANUFACTURER

[SKF](#)