

PWM 556370 SKF

Plain bushes

TYPE: Plain bearings, Bushings, thrust washers and strips, Bushings, Without flange, Filament wound (SKF)

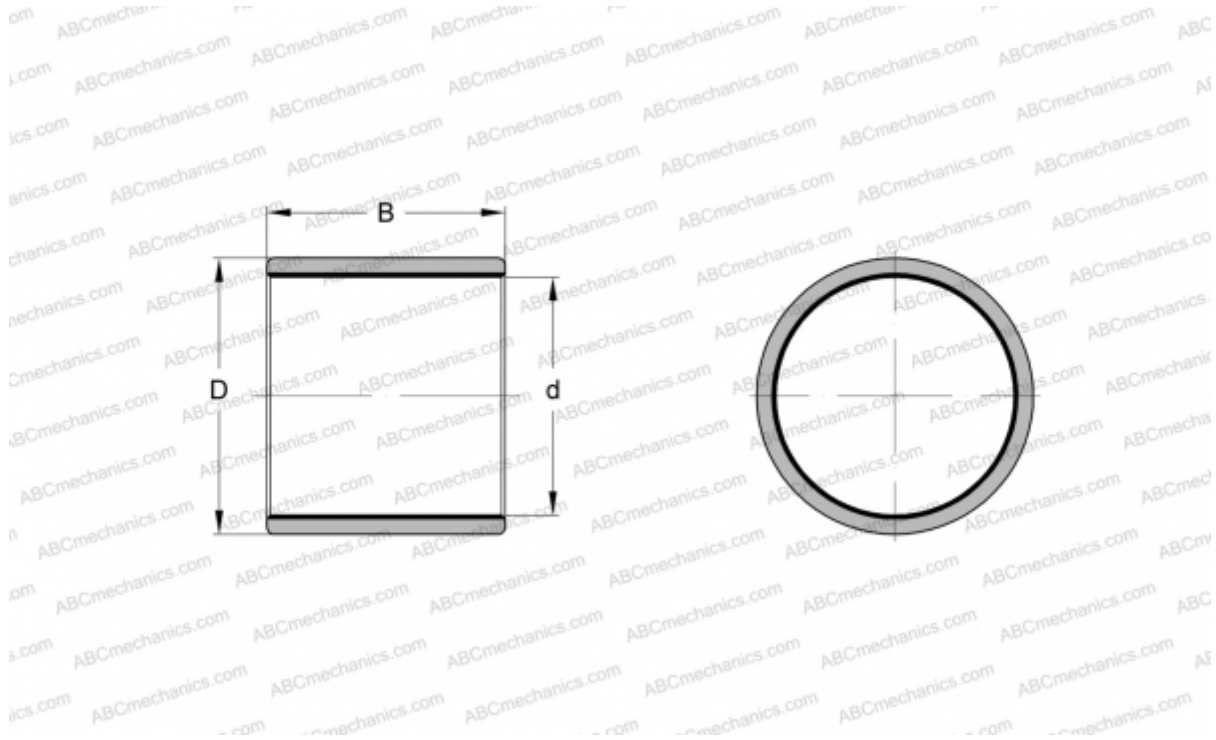

Technical specification

DIMENSIONS, MM

d	55,000
D	63,000
B	70,000

MANUFACTURER

[SKF](#)