

PWM 657580 SKF

Plain bushes

TYPE: Plain bearings, Bushings, thrust washers and strips, Bushings, Without flange, Filament wound (SKF)

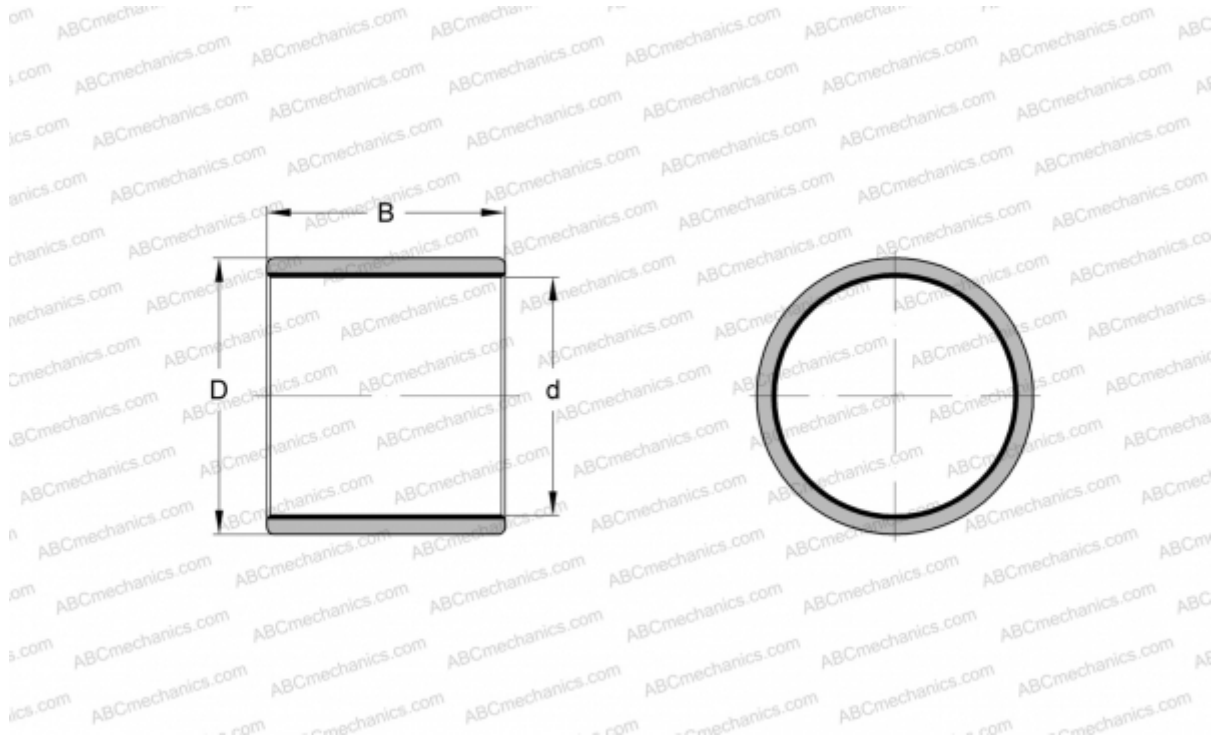

Technical specification

DIMENSIONS, MM

d	65,000
D	75,000
B	80,000

MANUFACTURER

[SKF](#)