

## PWM 708070 SKF

Plain bushes

TYPE: Plain bearings, Bushings, thrust washers and strips, Bushings, Without flange, Filament wound (SKF)

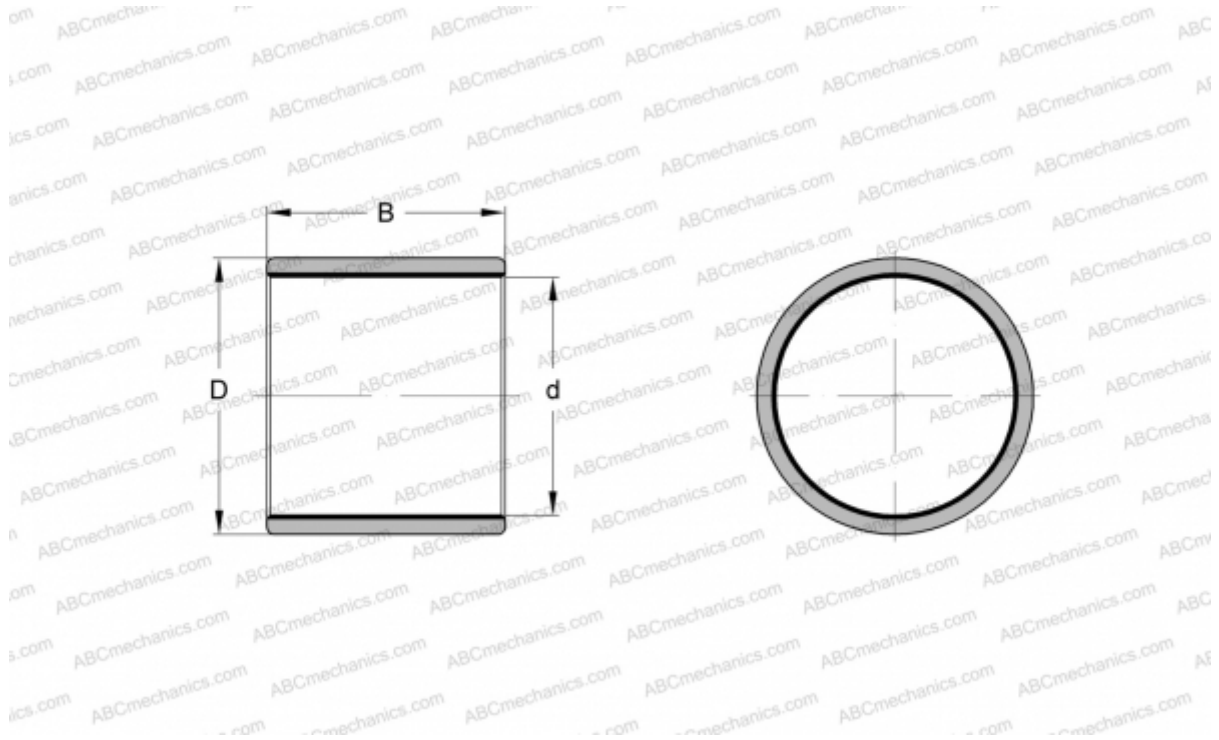

### Technical specification

#### DIMENSIONS, MM

d	70,000
D	80,000
B	70,000

#### MANUFACTURER

[SKF](#)