

PWM 809060 SKF

Plain bushes

TYPE: Plain bearings, Bushings, thrust washers and strips, Bushings, Without flange, Filament wound (SKF)

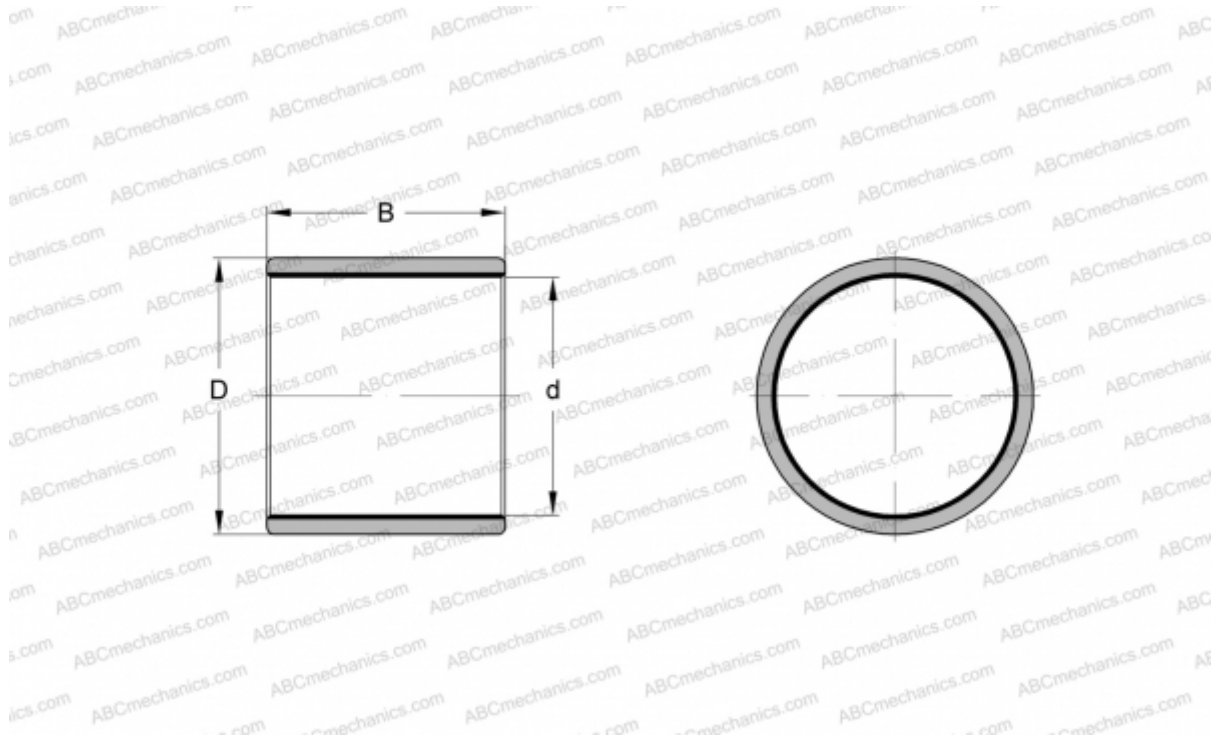

Technical specification

DIMENSIONS, MM

d	80,000
D	90,000
B	60,000

MANUFACTURER

[SKF](#)