

## PWM 809080 SKF

Plain bushes

TYPE: Plain bearings, Bushings, thrust washers and strips, Bushings, Without flange, Filament wound (SKF)

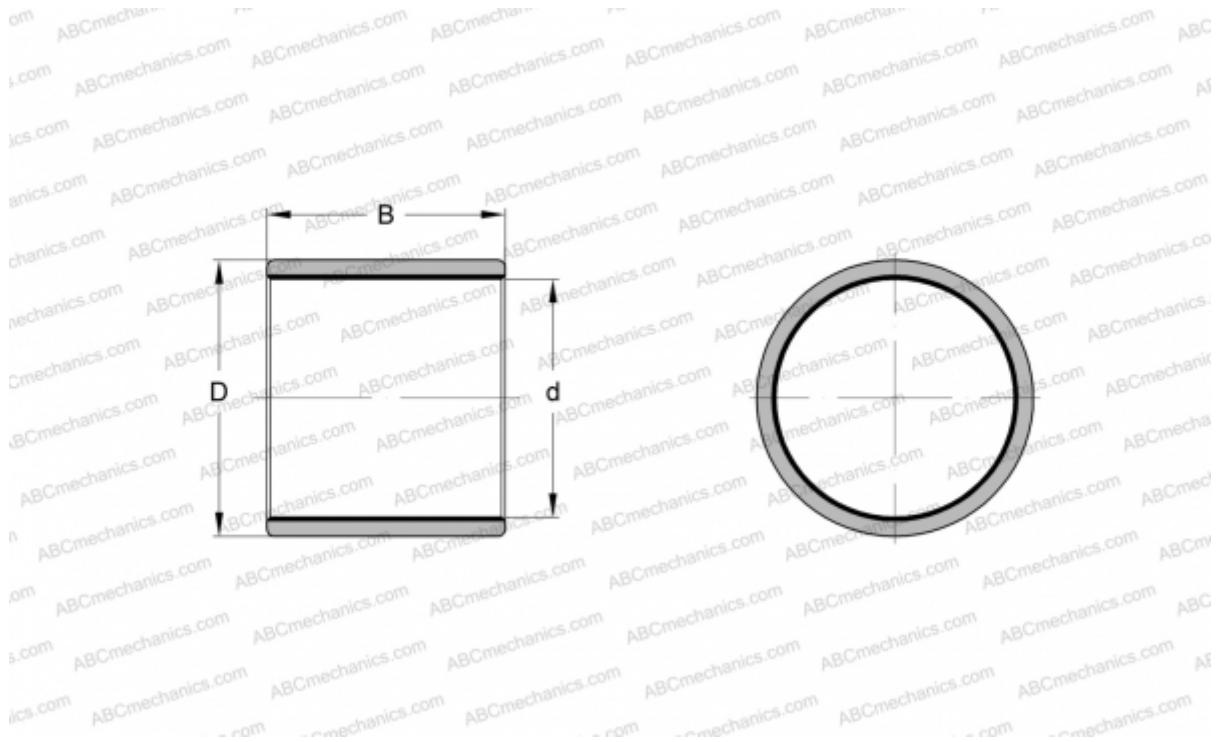

### Technical specification

#### DIMENSIONS, MM

d	80,000
D	90,000
B	80,000

#### MANUFACTURER

[SKF](#)