

## PWM 90105120 SKF

Plain bushes

TYPE: Plain bearings, Bushings, thrust washers and strips, Bushings, Without flange, Filament wound (SKF)

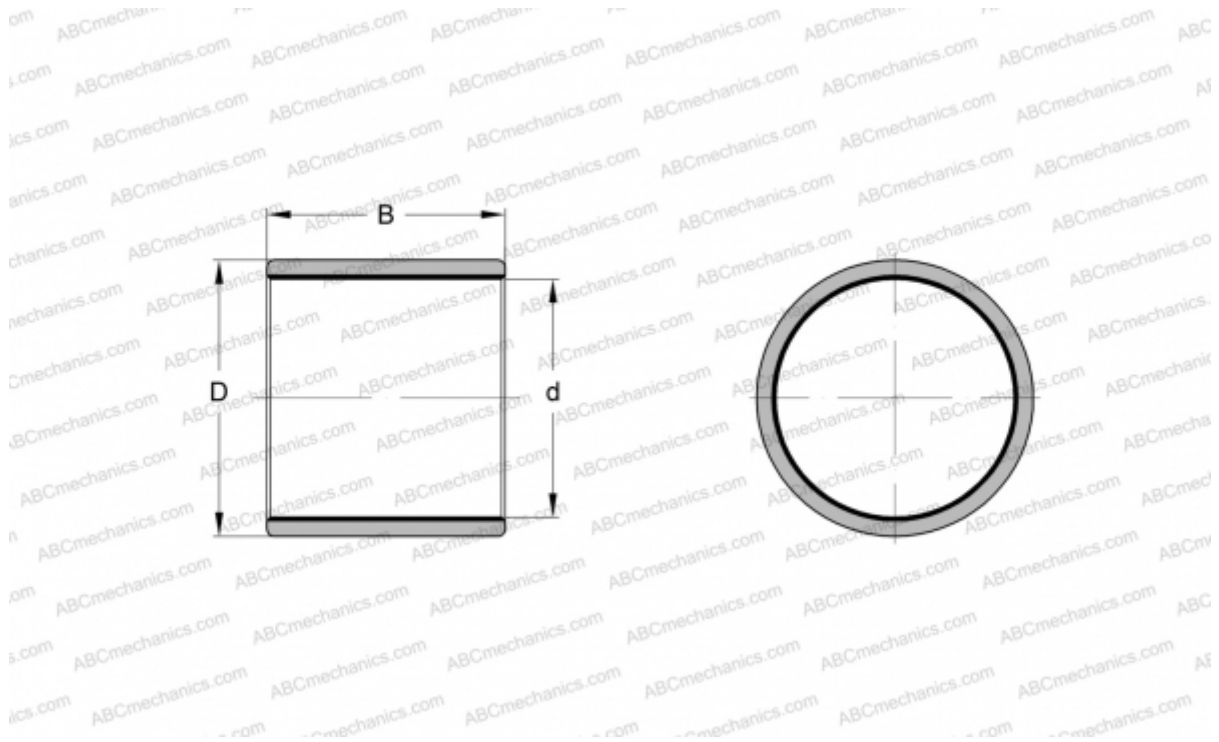

### Technical specification

#### DIMENSIONS, MM

d	90,000
D	105,000
B	120,000

#### MANUFACTURER

[SKF](#)