

PWM 10011580 SKF

Plain bushes

TYPE: Plain bearings, Bushings, thrust washers and strips, Bushings, Without flange, Filament wound (SKF)

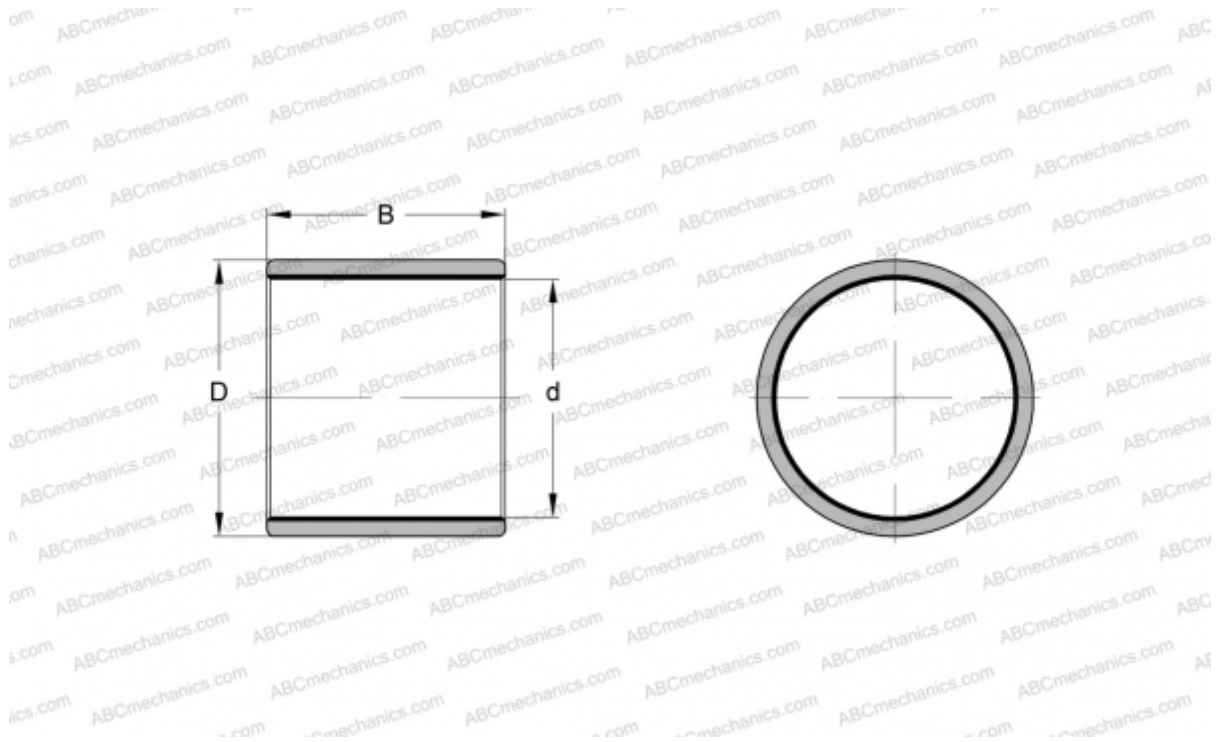

Technical specification

DIMENSIONS, MM

d	100,000
D	115,000
B	80,000

MANUFACTURER

[SKF](#)