

PWM 110125120 SKF

Plain bushes

TYPE: Plain bearings, Bushings, thrust washers and strips, Bushings, Without flange, Filament wound (SKF)

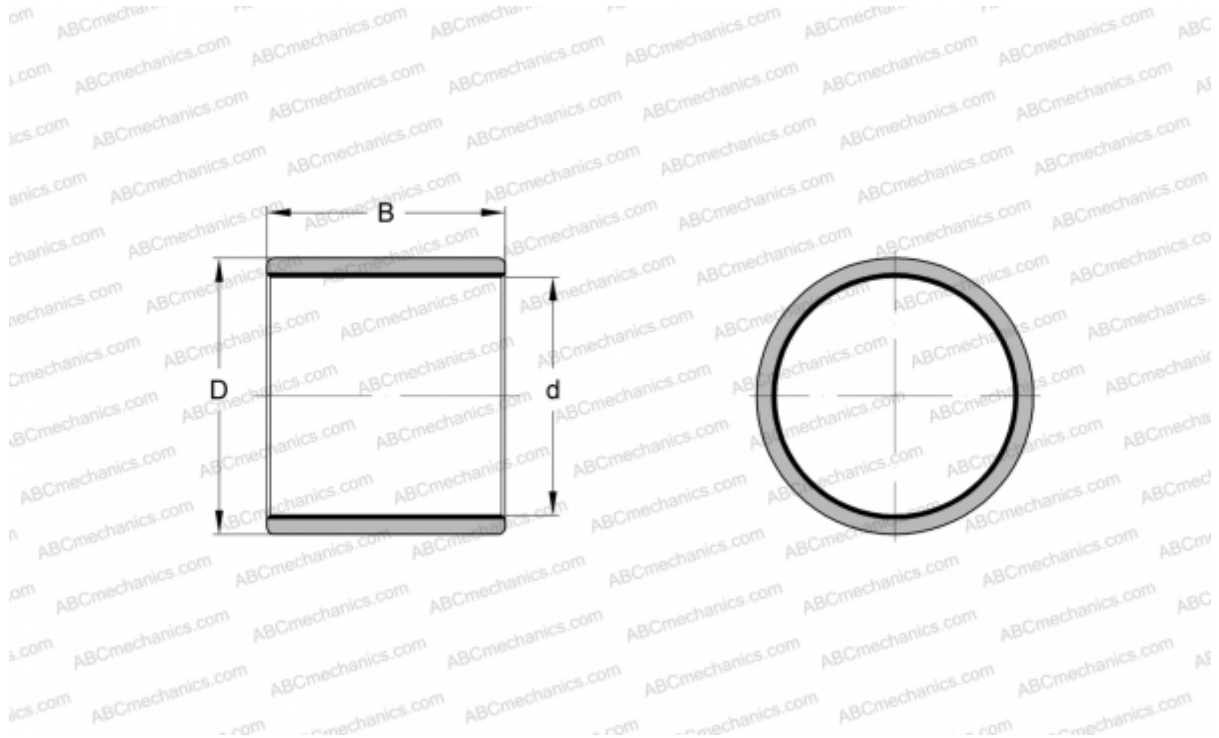

Technical specification

DIMENSIONS, MM

d	110,000
D	125,000
B	120,000

MANUFACTURER

[SKF](#)