

PWM 130145100 SKF

Plain bushes

TYPE: Plain bearings, Bushings, thrust washers and strips, Bushings, Without flange, Filament wound (SKF)

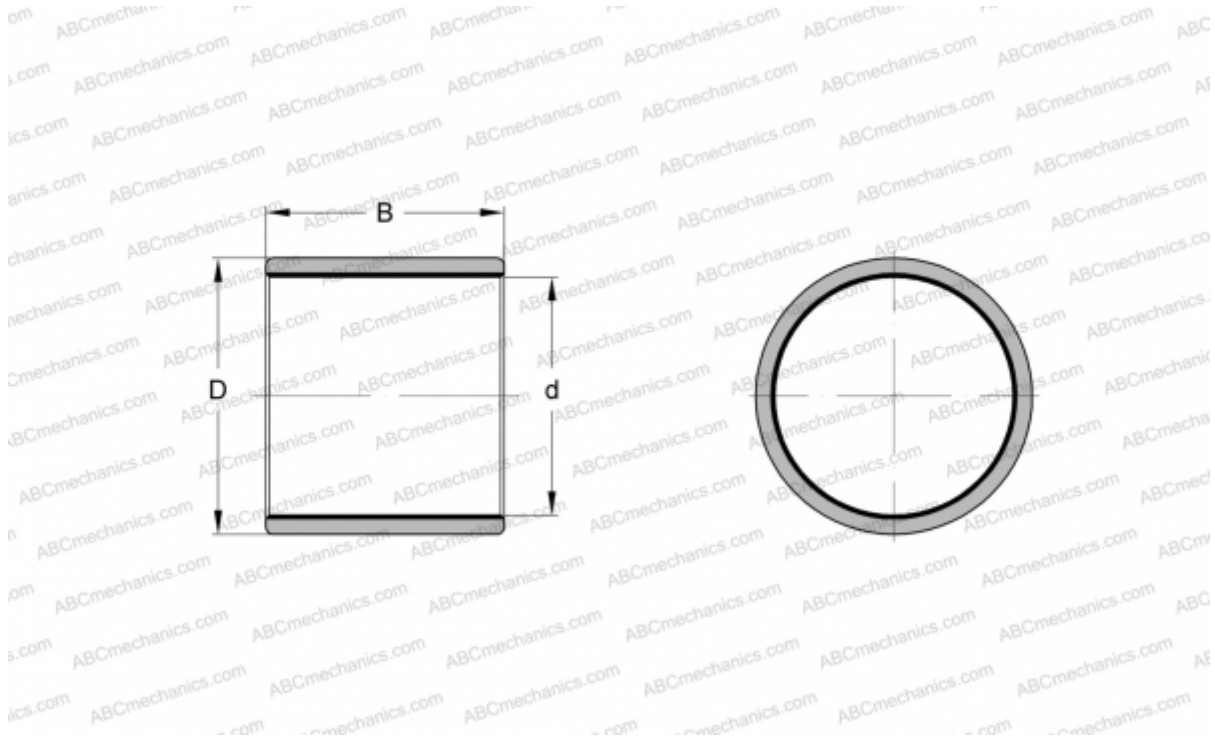

Technical specification

DIMENSIONS, MM

d	130,000
D	145,000
B	100,000

MANUFACTURER

[SKF](#)