

## PWM 140155100 SKF

Plain bushes

TYPE: Plain bearings, Bushings, thrust washers and strips, Bushings, Without flange, Filament wound (SKF)

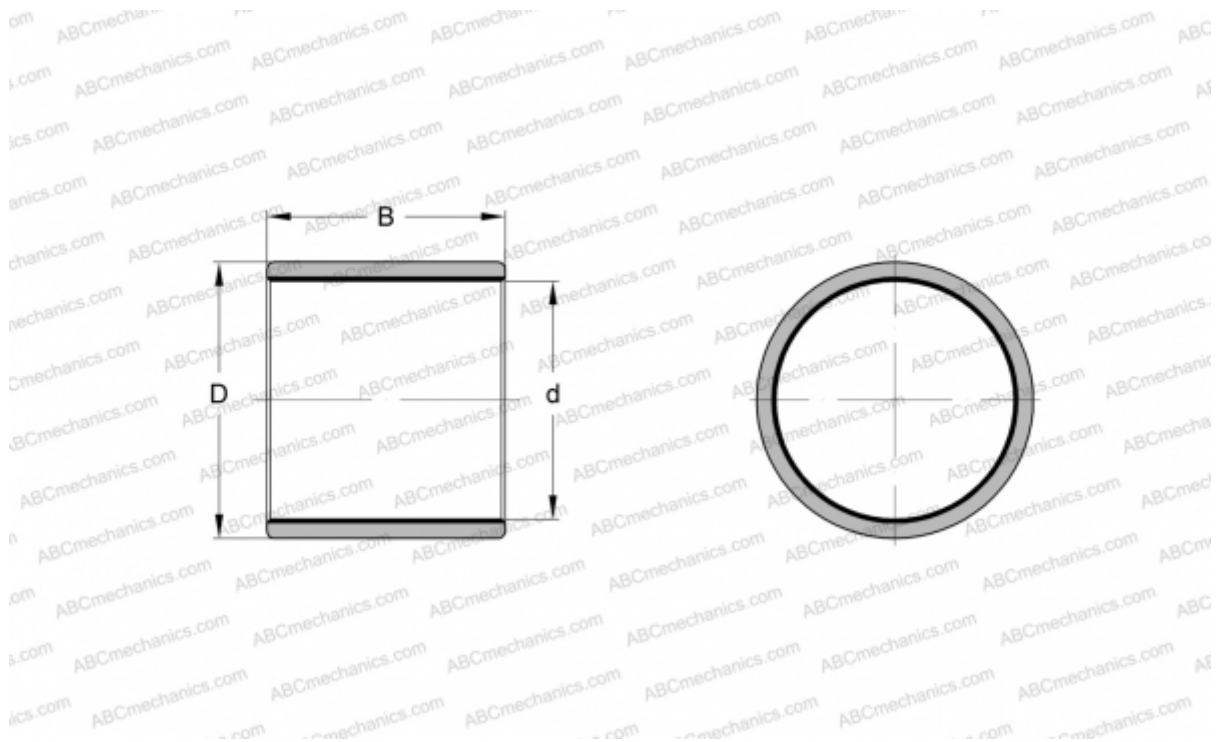

### Technical specification

#### DIMENSIONS, MM

d	140,000
D	155,000
B	100,000

#### MANUFACTURER

[SKF](#)