

PWM 160180150 SKF

Plain bushes

TYPE: Plain bearings, Bushings, thrust washers and strips, Bushings, Without flange, Filament wound (SKF)

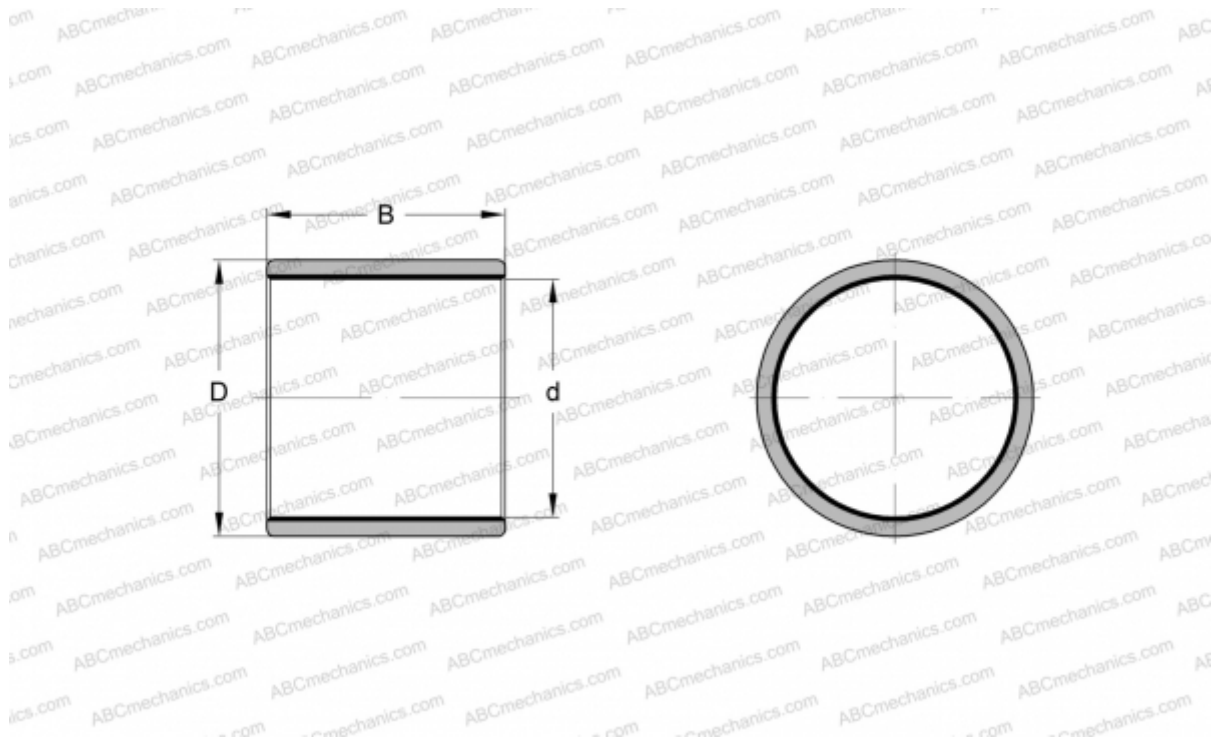

Technical specification

DIMENSIONS, MM

d	160,000
D	180,000
B	150,000

MANUFACTURER

[SKF](#)